

E-1

Universal engine monitor

Operating Manual – English 1.00



Introduction

The E-1 universal engine monitor combines in one compact 3.125" format instrument all that is needed to monitor the majority of smaller aircraft engines from two-stroke ultra-light engines to medium sized four strokes such as those from Rotax, Continental and Lycoming. Most automotive engine conversions can also benefit from the use of the E-1 engine monitor.

The E-1 can measure up to 4 EGT/CHT channels, a universal RPM input, a universal temperature/pressure sender input, and the aircrafts supply voltage.

1 Features

- 66 different engine setup configurations possible
- Universal, programmable rev counter (engine RPM) with digital and analog readout, with user programmable low and high alarm limits
- Programmable engine Hobbs meter (password protected) and running timer (flight timer) with automatic flight log
- Can monitor up to four programmable thermocouple channels for EGT and CHT probes with a user programmable high alarm limit
- A universal temperature sender input with a user programmable low and high alarm limits
- A universal pressure sender input with a user programmable low and high alarm limits
- Supply voltage measurement up to 30V with a user programmable low and high alarm limits
- Maximum recorded values for all measured values are stored in non-volatile memory
- High accuracy: Built in thermocouple linearization curves and cold junction compensation
- Thermocouple temperature probes can be common K, J or E-type thermocouple probes
- Uses standard automotive temperature and pressure senders
- Special Rotax 912/914 engine monitor mode utilizing the standard built in Rotax NTC CHT probes
- Supports the new Rotax 912/914 4-20mA oil pressure sender
- Standard 3.125" aircraft enclosure (can be front or rear mounted)
- Rotary control plus 2 independent buttons for easy menu navigation and user input
- External alarm output as well as a red LED illuminates when the alarm has been activated
- Large backlit graphic LCD with adjustable contrast
- Wide input supply voltage range of 8 to 30V DC with built in voltage reversal and over voltage protection for harsh electrical environments
- Light weight design
- Field upgradeable firmware
- 1 year limited warranty

2 E-1 Layout

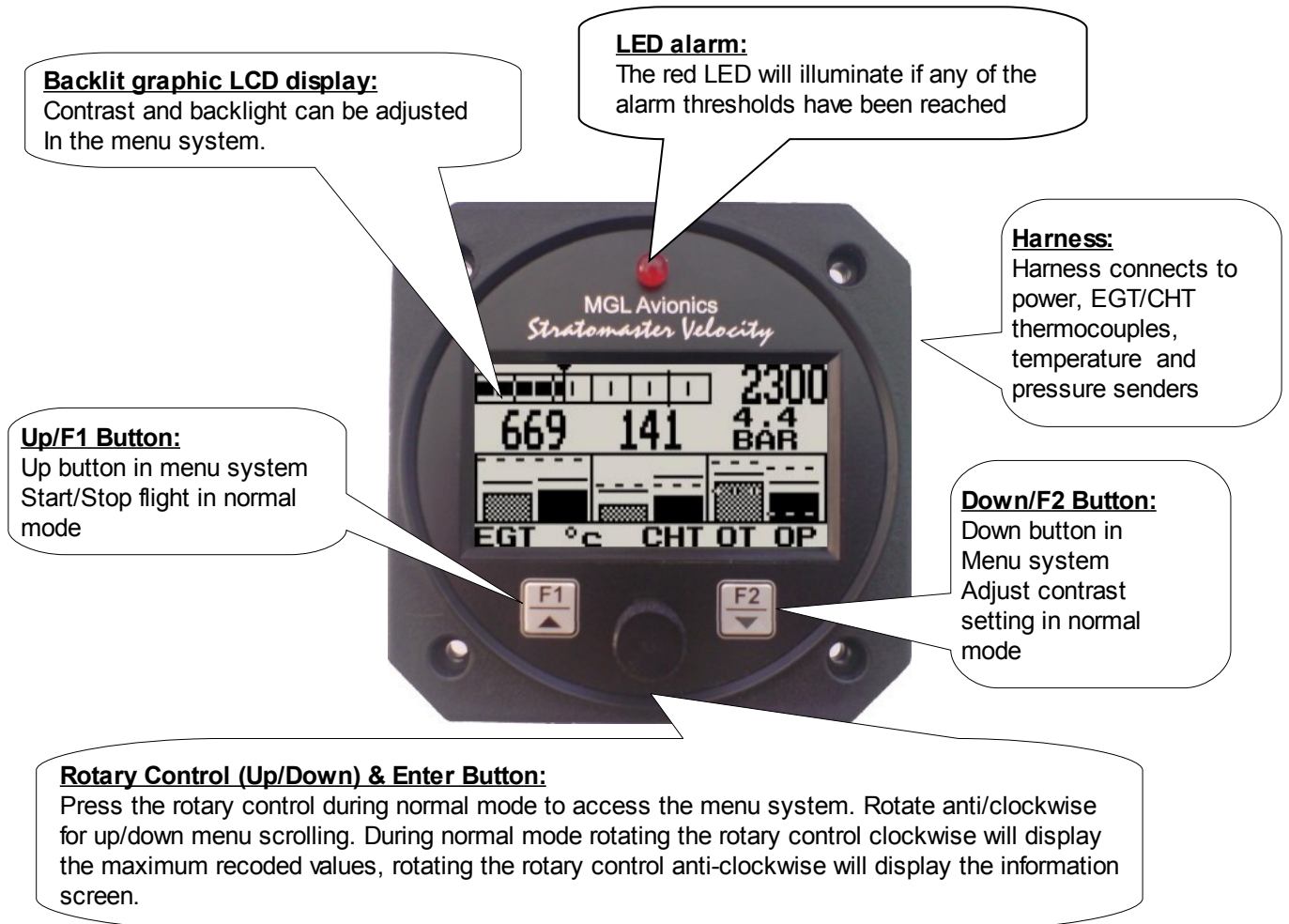

3 Main Display

The E-1 display can be customized to suite your engine measurement requirements. The E-1 will always try and maximize the display area in accordance to the measurement variables selected. The E-1 can be configured to how many EGT and CHT channels you want to display, and whether you want to display a temperature and/or pressure input. All senders can be disabled or enabled in the menu system.

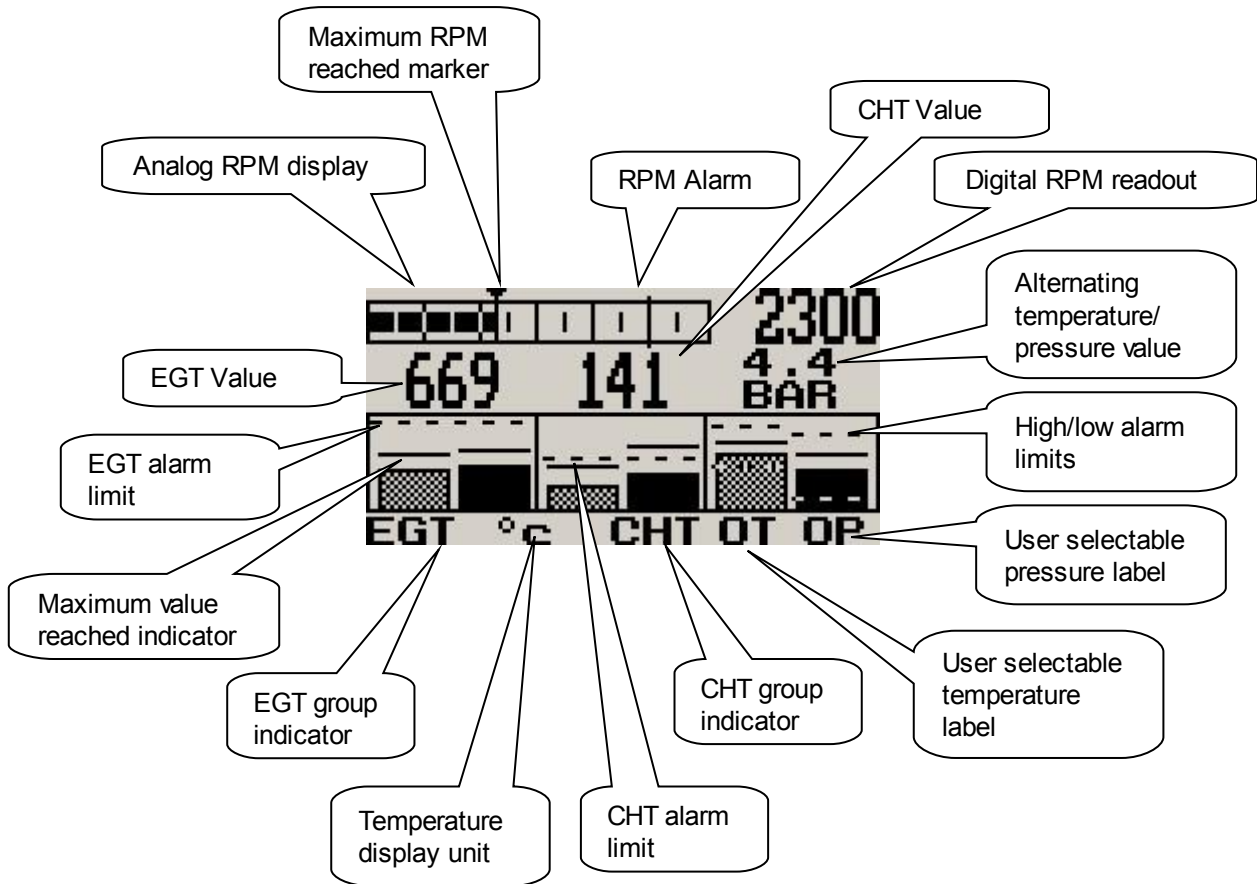

3.1 Flight Time / Hobbs Time / Voltage display

The flight time, Hobbs time and voltage displays will alternate at a predetermined interval when the E-1 measures zero RPM.



3.2 Special Rotax 912/914 display mode

In this mode the temperature and pressure NTC inputs becomes CHT channel one and CHT channel 2 respectively. All CHT setups must still be done under the "CHT SETUP" menu. The sender for the temperature and pressure setup must be set for "OFF". A probe setting "NTC" must be selected for the probe setting in the "CHT SETUP" menu. The number of EGT probes can be selected from 0 to 4.

The reason for using the NTC inputs is that the sensors Rotax use are standard NTC temperature probes and not of a thermocouple type.

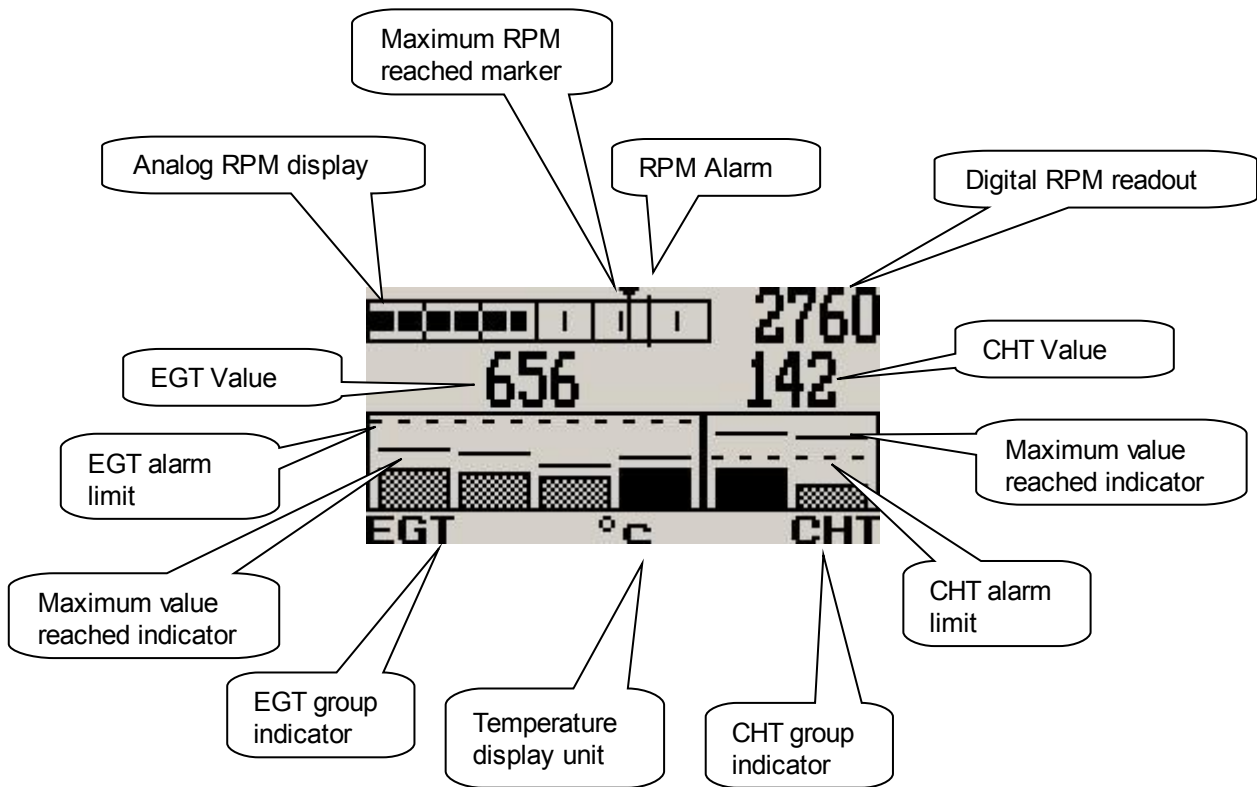

3.3 Start/Stop Flight Display



Press the F1 key during the normal display mode to manually start/stop a flight. This key is only active if the E-1 is setup to select the manual flight option under the "FLIGHT LOG" setup menu.

3.4 Contrast Display



This display can be accessed by pressing the F2 key during the normal display mode. This is a quick access key to the same contrast menu as in the menu system.

3.5 Maximum Values Display

This display can be accessed by rotating the rotary control clockwise during the normal display mode. Pressing the F1 key will reset the maximum values to the current values. Pressing any other key will cause the E-1 to resume to the normal display mode. To avoid false recordings, the maximum values function is only activated 10 seconds after the instrument has powered up.



Note: The permanent maximum values are stored in non-volatile memory and are recalled on power-up.

3.6 Information Display

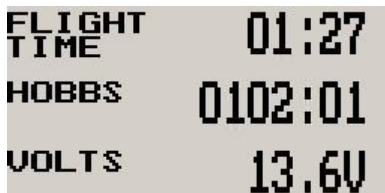

This display can be accessed by rotating the rotary control anti-clockwise during the normal display mode. This display shows the current flight time, the hobbs timer and the supply voltage value. Pressing any key will cause the E-1 to resume to the normal display mode.

3.7 Maintenance Timer

The purpose of this function is to assist you in determining remaining hours until maintenance will be required. It is not intended as a replacement for the aircraft's maintenance log. It is therefore important that the aircraft's maintenance log be maintained in the normal manner. You should further use your own discretion in performing maintenance earlier than indicated should any aircraft performance problems arise.

A maximum of 999 hours can be entered as a maintenance interval. The E-1 will deduct actual engine running time from the maintenance interval hours as set and will display the reminder message on startup when zero hours are remaining. The reminder message will automatically disappear after 5 seconds or if the pilot presses any key. Engine running time for the purpose of the maintenance timer is defined as the run time where the engine RPM is greater than the preset RPM for the Hobbs meter.

**MAINTENANCE
TIMER HAS
EXPIRED**

4 Menu System

Pressing the rotary control button during the normal display mode will cause the E-1 to enter the menu system. Use the up/down keys or the rotary control to navigate through the menu system.

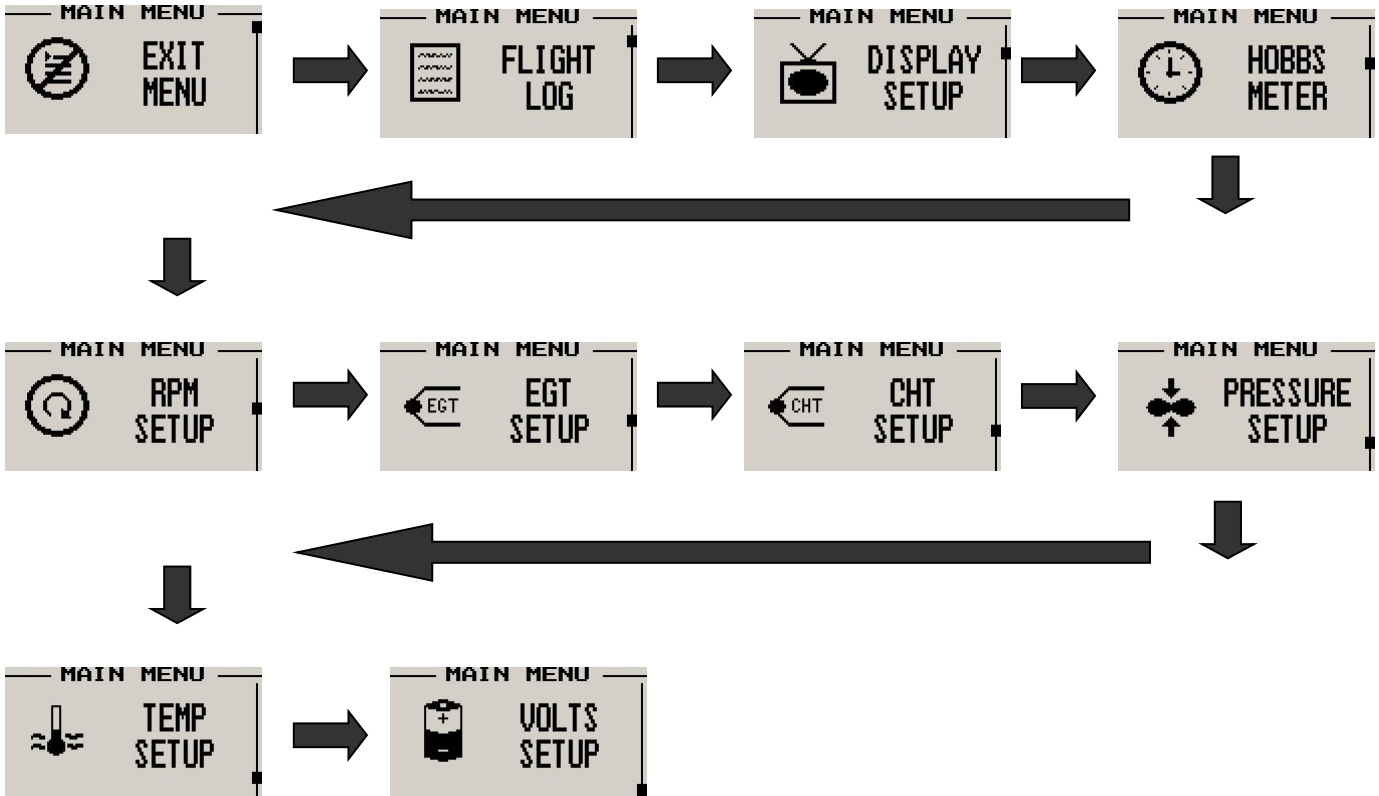

4.1 Exit Menu



Pressing the rotary control on this menu item will cause the E-1 to exit the menu system. All changes made during navigation of the menu system will be saved in non-volatile memory on exiting the menu system. If you remove power before exiting the menu the instrument will not save any changes.

4.2 Flight Log



Select whether the instrument should detect the start and end of flights automatically or if you would like to do this manually. We recommend you select automatic flight detect. With automatic flight detection, flights will start logging when the engine RPM is above the take-off limit. A flight is considered ended when the engine RPM is less than the RPM take-off limit for more than 30 seconds.



Move the highlight over the “DONE” option and press the rotary button to return to the main menu.



Select this function to view the flight log. The flight log contains the duration of each of the last 24 logged flights. Duration is displayed in hours and minutes. Use the up/down or the rotary control to navigate through the log. Empty log entries are shown as “----”.

Note: You cannot select this function while a flight is in progress.



Pressing the F1 key will erase all the flight log entries.



Select whether you want the E-1 to automatically detect a flight or whether the pilot must press the F1 key to start/stop a flight. We recommend you select automatic flight detection.



This menu option is only shown if the “DETECT” flight mode is selected. Enter the engine RPM take-off threshold that you want a flight log entry to start.

4.3 Display Setup



Move the highlight over the “DONE” menu item and press the rotary button to return to the main menu.

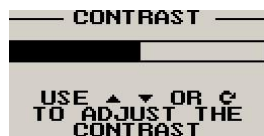

Select this menu option to adjust the display contrast.



Select this menu option to turn the backlight on or off.

4.4 Hobbs Meter



Move the highlight over the “DONE” menu option and press the rotary button to return to the main menu.

```

HOBBS METER
*** DONE ***
HOBBS RPM: 1000
SET HOBBS TIME
SET MAINT TIME
HOUR FRACT: MIN
HOBBS CODE
    
```

Enter the RPM limit in which the Hobbs meter/maintenance timer must start counting.

```

HOBBS METER
*** DONE ***
HOBBS RPM: 1000
SET HOBBS TIME
SET MAINT TIME
HOUR FRACT: MIN
HOBBS CODE
    
```

```

USE ▲ ▼ OR ⌚
TO ADJUST THE
HOBBS TIME

0000:00
    
```

This function allows you to set the engine Hobbs meter to any value. Typically, you would use this function to set the Hobbs meter to the current known engine time. Use the up/down or the rotary control to change the value. Press the rotary control to accept and exit the menu option. If the Hobbs code is set to another value beside zero, then the pilot will be prompted to enter the Hobbs access code before allowing him to change the Hobbs time. This feature is useful for charted and flying school planes.

```

HOBBS METER
*** DONE ***
HOBBS RPM: 1000
SET HOBBS TIME
SET MAINT TIME
HOUR FRACT: MIN
HOBBS CODE
    
```

```

USE ▲ ▼ OR ⌚
TO ADJUST THE
MAINTENANCE
TIME

000 Hours
    
```

This function allows you to set an engine maintenance timer. This timer is set in engine hours and it will count down to zero when the engine RPM is greater then the Hobbs RPM limit. A good use for this function is to set the hours until your next spark plug change or engine inspection. Use the up/down or the rotary control to change the value. Press the rotary control to accept and exit the menu option.

```

HOBBS METER
*** DONE ***
HOBBS RPM: 1000
SET HOBBS TIME
SET MAINT TIME
HOUR FRACT: MIN
HOBBS CODE
    
```

Select if you would like the hour to be displayed in decimal fractions (0-99) or minutes (0-59). This setting influences the current flight time display and the flight log.

```

HOBBS METER
*** DONE ***
HOBBS RPM: 1000
SET HOBBS TIME
SET MAINT TIME
HOUR FRACT: MIN
HOBBS CODE
    
```

This menu option allows you to change the Hobbs access code. You will first be prompted to enter the current code followed by entering in a new code followed by re-entering the new code. If the new code and the re-entered code is the same, then the Hobbs access code will be changed. **Default code is 0000.**

```

ENTER CURRENT
CODE

0000
    
```



```

ENTER NEW
CODE

0000
    
```



```

CONFIRM NEW
CODE

0000
    
```



```

MESSAGE
! CODE
CHANGED
    
```

4.5 RPM Setup

```

MAIN MENU
RPM
SETUP
    
```

All the RPM related settings can be setup here.

```

RPM SETUP
*** DONE ***
SCALE: 6000
LOW ALARM: OFF
LOW ALARM: 600
HIGH ALARM: ON
HIGH ALARM: 5000
PULSE/REV: 6.0
    
```

Move the highlight over the "DONE" menu option and press the rotary button to return to the main menu.

```

RPM SETUP
*** DONE ***
SCALE: 6000
LOW ALARM: OFF
LOW ALARM: 600
HIGH ALARM: ON
HIGH ALARM: 5000
PULSE/REV: 6.0
    
```

Select the maximum value that you want the RPM analog bar graph display to show. This can give you increased display resolution.

```

RPM SETUP
*** DONE ***
SCALE: 6000
LOW ALARM: OFF
LOW ALARM: 600
HIGH ALARM: ON
HIGH ALARM: 5000
PULSE/REV: 6.0
    
```

Select whether you want the RPM low alarm to be turned on or off.

```

RPM SETUP
*** DONE ***
SCALE: 6000
LOW ALARM: OFF
LOW ALARM: 600
HIGH ALARM: ON
HIGH ALARM: 5000
PULSE/REV: 6.0
    
```

Enter the low RPM alarm activation threshold. Any RPM value below this value will activate the alarm.

```

RPM SETUP
*** DONE ***
SCALE: 6000
LOW ALARM: OFF
LOW ALARM: 600
HIGH ALARM: ON
HIGH ALARM: 5000
PULSE/REV: 6.0
    
```

Select whether you want the RPM high alarm to be turned on or off.

```

RPM SETUP
*** DONE ***
SCALE: 6000
LOW ALARM: OFF
LOW ALARM: 600
HIGH ALARM: ON
HIGH ALARM: 5000
PULSE/REV: 6.0
    
```

Enter the high RPM alarm activation threshold. Any RPM value above this value will activate the alarm.

```

RPM SETUP
*** DONE ***
SCALE: 6000
LOW ALARM: OFF
LOW ALARM: 600
HIGH ALARM: ON
HIGH ALARM: 5000
PULSE/REV: 6.0
    
```

Enter the number of pulses per RPM. For engines with an uneven number of cylinders like three cylinder four stroke engines you can enter values containing fractions (usually 1.5 in this example). Most four stroke engines will generate one pulse for every two revolutions per cylinder. A four cylinder automotive four stroke engine will thus generate 2 pulses per revolution. A typical Rotax DCDI two stroke engine will generate 6 pulses per revolution. The well known Rotax 912/914 engine generates one pulse per revolution.

```

RPM SETUP
*** DONE ***
SCALE: 6000
LOW ALARM: OFF
LOW ALARM: 600
HIGH ALARM: ON
HIGH ALARM: 5000
PULSE/REV: 6.0
PULSE: PULSE
TIME: PULSE
    
```

PULSE: The E-1 counts pulses from the engine for 1/2 second period (fast frequency input).
 TIME: The E-1 uses the time between pulses to calculate revs (slow frequency input).

Typical setups:

- Rotax 503,582 DCDI – Pulse (Fast frequency) (6 pulses per revolution)
- Rotax 503 single ignition, Rotax 912/914 – Time (Slow frequency) (one pulse per revolution)
- Gyro Rotor RPM with gear tooth sensor - Pulse (Fast frequency) (about 100 pulses per revolution)
- Gyro Rotor RPM with single hall-effect sensor – Time (Slow frequency) (one pulse per revolution)
- Helicopter Rotor RPM with single hall-effect sensor – Time (Slow frequency) (one pulse per revolution)

```

RPM SETUP
LOW ALARM: OFF
LOW ALARM: 600
HIGH ALARM: ON
HIGH ALARM: 5000
PULSE/REV: 6.0
PULSE: PULSE
TIME: PULSE
    
```

The E-1 unit contains a digital filter. This filter is used to achieve a higher resolution of the digital rev counter than is available in ordinary operation. In digital rev counters, resolution is largely dependant on the amount of time given to measure RPM. The more time that is available, the higher the resolution will be. However, on the downside of this, the more sluggish the display will react to changes in engine settings. Resolution with the E-1 is dependent on the number of pulses per rev and the type of measurement method you have selected (pulse fast/slow). The update rate for the measurement is a fixed, fast 0.5 seconds. The digital filter is activated whenever input revs are fairly constant and this results in a very high resolution of the digital RPM display in a short time span. The filter needs to be setup for the expected base resolution. This can be between 10 and 30 RPM for most setups. The filter has the following settings:

Scale -The setting is made dependent on your scale selection from 500 to 20000 RPM. The filter factor is fixed as follows:

Scale 500 – 10 RPM	Scale 10000 – 200 RPM
Scale 1000 – 20 RPM	Scale 10500 – 210 RPM
Scale 1500 – 30 RPM	Scale 11000 – 220 RPM
Scale 2000 – 40 RPM	Scale 11500 – 230 RPM
Scale 2500 – 50 RPM	Scale 12000 – 240 RPM
Scale 3000 – 60 RPM	Scale 12500 – 250 RPM
Scale 3500 – 70 RPM	Scale 13000 – 260 RPM
Scale 4000 – 80 RPM	Scale 13500 – 270 RPM
Scale 4500 – 90 RPM	Scale 14000 – 280 RPM
Scale 5000 – 100 RPM	Scale 14500 – 290 RPM
Scale 5500 – 110 RPM	Scale 15000 – 300 RPM
Scale 6000 – 120 RPM	Scale 15500 – 310 RPM
Scale 6500 – 130 RPM	Scale 16000 – 320 RPM
Scale 7000 – 140 RPM	Scale 16500 – 330 RPM

Scale 7500 – 150 RPM	Scale 17000 – 340 RPM
Scale 8000 – 160 RPM	Scale 17500 – 350 RPM
Scale 8500 – 170 RPM	Scale 18000 – 360 RPM
Scale 9000 – 180 RPM	Scale 18500 – 370 RPM
Scale 9500 – 190 RPM	Scale 19000 – 380 RPM

10,20,30,40,50,60,70,80,90,100 – The filter factor can be set to any of these values independent of your scale selection. Choose a filter setting that results in a smooth, high resolution RPM display. A filter setting too low for your setup will result in a “jumpy” display. RPM display will change at your base resolution and no smoothing will happen. Choose the lowest setting that will result in a smooth display for greatest sensitivity of the reading.

4.6 EGT (Exhaust Gas Temperature) Setup



Move the highlight over the “DONE” menu option and press the rotary button to return to the main menu.



Select the number of EGT channels you want to use. Choices are from 1 to 4. The temperature display will configure itself to make best possible use of the available display size. Please note that the minimum number of EGT and CHT channels that can be displayed is 1 and the maximum number of EGT and CHT channels that can be displayed is 4.



A selection between “HIGHEST” or “SCANNING” can be selected. If “HIGHEST” is selected then the current highest thermocouple temperature is displayed. If “SCANNING” is selected then the E-3 will cycle through each thermocouple channel highlighting it as well as showing its temperature.



This function sets the top end of your temperature bar graph. It has no effect on the actual temperature range that can be displayed in the digital temperature readout. Select the range to be just higher than the highest temperature you expect to measure using this channel.



Select this function to “ON” if you want the bar graph display to show the upper half of the temperature range only. This results in a higher resolution of the temperature range that you may be interested in. For engine temperature measurements we recommend that you set this to “ON”.

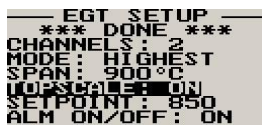

Adjust the temperature that you would like to use as an alarm limit. Any temperature above this limit will activate the alarm. Active alarms will flash the affected channel and also activate the alarm contact that you can use to switch a lamp on.



Select whether you want to turn the alarm on or off. To avoid false activation of the alarms, the alarm function is only activated 10 seconds after the instrument has powered up.



Select if you are using a K-type, J-type or E-type thermocouple probe for this channel. All probes supplied by MGL Avionics are K-Type. J-types are sometimes used with American made CHT probes. All EGT probes are K-type. E-type probes are seldom used.



```

EGT SETUP
MODE: HIGHEST
SPAN: 900°C
TOPSCALE: ON
SETPOINT: 850
ALM ON/OFF: ON
PROBE: K-TYPE
TEMP UNIT: °C

```

Select whether you want all the temperature values to be displayed in degrees Fahrenheit (°F) or in degrees Celsius (°C).

4.7 CHT (Cylinder Head Temperature) Setup

```

MAIN MENU
CHT
CHT
SETUP

```

```

CHT SETUP
*** DONE ***
CHANNELS: 2
MODE: HIGHEST
SPAN: 200°C
TOPSCALE: ON
SETPOINT: 150
ALM ON/OFF: ON

```

Move the highlight over the “DONE” menu option and press the rotary button to return to the main menu.

```

CHT SETUP
*** DONE ***
CHANNELS: 2
MODE: HIGHEST
SPAN: 200°C
TOPSCALE: ON
SETPOINT: 150
ALM ON/OFF: ON

```

Select the number of CHT channels you want to use. Choices are from 1 to 4. The temperature display will configure itself to make best possible use of the available display size. Please note that the maximum number of EGT and CHT channels that can be displayed is 4.

```

CHT SETUP
*** DONE ***
CHANNELS: 2
MODE: HIGHEST
SPAN: 200°C
TOPSCALE: ON
SETPOINT: 150
ALM ON/OFF: ON

```

A selection between “HIGHEST” or “SCANNING” can be selected. If “HIGHEST” is selected then the current highest thermocouple temperature is displayed. If “SCANNING” is selected then the E-3 will cycle through each thermocouple channel highlighting it as well as showing its temperature.

```

CHT SETUP
*** DONE ***
CHANNELS: 2
MODE: HIGHEST
SPAN: 200°C
TOPSCALE: ON
SETPOINT: 150
ALM ON/OFF: ON

```

This function sets the top end of your temperature bar graph. It has no effect on the actual temperature range that can be displayed in the digital temperature readout. Select the range to be just higher than the highest temperature you expect to measure using this channel.

```

CHT SETUP
*** DONE ***
CHANNELS: 2
MODE: HIGHEST
SPAN: 200°C
TOPSCALE: ON
SETPOINT: 150
ALM ON/OFF: ON

```

Select this function to “ON” if you want the bar graph display to show the upper half of the temperature range only. This results in a higher resolution of the temperature range that you may be interested in. For engine temperature measurements we recommend that you set this to “ON”.

```

CHT SETUP
*** DONE ***
CHANNELS: 2
MODE: HIGHEST
SPAN: 200°C
TOPSCALE: ON
SETPOINT: 150
ALM ON/OFF: ON

```

Adjust the temperature that you would like to use as an alarm limit. Any temperature above this limit will activate the alarm. Active alarms will flash the affected channel and also activate the alarm contact that you can use to switch a lamp on.

```

CHT SETUP
*** DONE ***
CHANNELS: 2
MODE: HIGHEST
SPAN: 200°C
TOPSCALE: ON
SETPOINT: 150
ALM ON/OFF: ON

```

Select whether you want to turn the alarm on or off. To avoid false activation of the alarms, the alarm function is only activated 10 seconds after the instrument has powered up.

```

CHT SETUP
CHANNELS: 2
MODE: HIGHEST
SPAN: 200°C
TOPSCALE: ON
SETPOINT: 150
ALM ON/OFF: ON
PROBE: K-TYPE
TEMP UNIT: °C

```

Select if you are using a K-type, J-type or E-type thermocouple probe for this channel. All probes supplied by MGL Avionics are K-Type. J-types are sometimes used with American made CHT probes. All EGT probes are K-type. E-type probes are seldom used. If the probe type is set for “NTC” and the temperature and pressure senders are disabled and 1 or 2 CHT channels are selected then the unit will enter a special Rotax 912/914 display mode.

```

CHT SETUP
MODE: HIGHEST
SPAN: 200°C
TOPSCALE: ON
SETPOINT: 150
ALM ON/OFF: ON
PROBE: K-TYPE
TEMP UNIT: °C

```

Select whether you want all the temperature values to be displayed in degrees Fahrenheit (°F) or in degrees Celsius (°C).

4.8 Pressure Setup

```
- PRESSURE SETUP
*** DONE ***
PRESS DISP: ON
TYPE: RESISTIVE
SENDER: VDO
MAX RES: 180Ω
MAX PRESS: 10.0
SENDER DIR: INC
```

Move the highlight over the “DONE” menu option and press the rotary button to return to the main menu.

```
- PRESSURE SETUP
*** DONE ***
PRESS DISP: ON
TYPE: RESISTIVE
SENDER: VDO
MAX RES: 180Ω
MAX PRESS: 10.0
SENDER DIR: INC
```

Select whether to use the the pressure sender or not. Switching it to off will disable the pressure display on the main screen.

```
- PRESSURE SETUP
*** DONE ***
PRESS DISP: ON
TYPE: RESISTIVE
SENDER: VDO
MAX RES: 180Ω
MAX PRESS: 10.0
SENDER DIR: INC
```

Select if you are using a resistive, 4-20mA or 0-5V output pressure sender.

If the “Resistive” pressure sender is selected

```
- PRESSURE SETUP
*** DONE ***
PRESS DISP: ON
TYPE: RESISTIVE
SENDER: VDO
MAX RES: 180Ω
MAX PRESS: 10.0
SENDER DIR: INC
```

Select what type of resistive pressure sender you are using. Select “VDO” for VDO / resistive senders, “USER” for a custom sender.

```
- PRESSURE SETUP
*** DONE ***
PRESS DISP: ON
TYPE: RESISTIVE
SENDER: VDO
MAX RES: 180Ω
MAX PRESS: 10.0
SENDER DIR: INC
```

Enter the maximum resistance of your pressure sender. Common VDO pressure senders are typically 180 Ohms.

```
- PRESSURE SETUP
*** DONE ***
PRESS DISP: ON
TYPE: RESISTIVE
SENDER: VDO
MAX RES: 180Ω
MAX PRESS: 10.0
SENDER DIR: INC
```

Enter the maximum pressure for your pressure sender. If you are using a VDO 10 bar pressure sender then enter in 10.0, if you are using a VDO 5 bar, then enter in 5.0, if you are using a VDO 2 bar then enter in 2.0. Enter the maximum pressure in the selected unit VDO 10BAR = 145PSI.

```
- PRESSURE SETUP
*** DONE ***
PRESS DISP: ON
TYPE: RESISTIVE
SENDER: VDO
MAX RES: 180Ω
MAX PRESS: 10.0
SENDER DIR: INC
```

Select whether your pressure sender increases resistance with pressure or decreases resistance with pressure. VDO senders normally increase resistance with pressure.

If the “0-5V” pressure sender is selected

```
- PRESSURE SETUP
*** DONE ***
PRESS DISP: ON
TYPE: 0-5V
SENDER: UMA
MODEL: T1E007
LABEL: OIL
UNIT: BAR
```

Select the type of 0-5V sender used. Select “UMA” for UMA senders of “USER” for a custom 0-5V sender.

```
- PRESSURE SETUP
*** DONE ***
PRESS DISP: ON
TYPE: 0-5V
SENDER: UMA
MODEL: T1E007
LABEL: OIL
UNIT: BAR
```

For UMA senders select the UMA model number.

If the “4-20mA” pressure sender is selected

```
- PRESSURE SETUP
*** DONE ***
PRESS DISP: ON
TYPE: 4-20mA
SENDER: VDO
PRESS 4mA: 0.0
PRESS 20mA: 10.0
LABEL: OIL
```

Select the type of 4-20mA sender used. Select “VDO” for VDO senders or “USER” for a custom 4-20mA sender.

```
- PRESSURE SETUP -
*** DONE ***
PRESS DISP: ON
TYPE: 4-20mA
SENDER: VDO
PRESS 4mA: 0.0
PRESS 20mA: 10.0
LABEL: OIL
```

Enter the pressure specified at 4mA output.

```
- PRESSURE SETUP -
*** DONE ***
PRESS DISP: ON
TYPE: 4-20mA
SENDER: VDO
PRESS 4mA: 0.0
PRESS 20mA: 10.0
LABEL: OIL
```

Enter the pressure specified at 20mA output.

If the “User” pressure sender is selected

```
- PRESSURE SETUP -
*** DONE ***
PRESS DISP: ON
TYPE: RESISTIVE
SENDER: USER
CALIBRATE SENDER
LABEL: OIL
UNIT: BAR
```

A custom sensor can be interfaced to the E-1. This sensor can be a resistive, 4-20mA or 0-5V sender.

```
- PRESSURE SETUP -
*** DONE ***
PRESS DISP: ON
TYPE: RESISTIVE
SENDER: USER
CALIBRATE SENDER
LABEL: OIL
UNIT: BAR
```

If the sender type is set to “USER”, then use this menu option to calibrate your pressure sender. See section 4.10 for more information.

Menu options for all sender types

```
- PRESSURE SETUP -
PRESS DISP: ON
TYPE: RESISTIVE
SENDER: VDO
MAX RES: 180Ω
MAX PRESS: 10.0
SENDER DIR: INC
LABEL: OIL
```

Choose one of a selection of labels to suit your pressure input so you can identify it easily.

```
- PRESSURE SETUP -
TYPE: RESISTIVE
SENDER: VDO
MAX RES: 180Ω
MAX PRESS: 10.0
SENDER DIR: INC
LABEL: OIL
UNIT: BAR
```

Select whether you want to display the pressure in Bar, PSI or PSI(0.1). The PSI(0.1) is for low range pressure senders e.g. UMA 7PSI.

```
- PRESSURE SETUP -
SENDER: VDO
MAX RES: 180Ω
MAX PRESS: 10.0
SENDER DIR: INC
LABEL: OIL
UNIT: BAR
SPAN: 10.0 BAR
```

Set the range of the pressure sender. This is the maximum that the bargraph display will go to.

```
- PRESSURE SETUP -
MAX RES: 180Ω
MAX PRESS: 10.0
SENDER DIR: INC
LABEL: OIL
UNIT: BAR
SPAN: 10.0 BAR
TOPSCALE: OFF
```

This allows the user to zoom into the top half of the bar graph resulting in a higher display resolution. This option set to “ON” is recommended.

```
- PRESSURE SETUP -
MAX PRESS: 10.0
SENDER DIR: INC
LABEL: OIL
UNIT: BAR
SPAN: 10.0 BAR
TOPSCALE: OFF
ALARM LOW: ON
```

Select whether to use the low pressure alarm.

```
- PRESSURE SETUP -
SENDER DIR: INC
LABEL: OIL
UNIT: BAR
SPAN: 10.0 BAR
TOPSCALE: OFF
ALARM LOW: ON
ALARM HIGH: 1.5
```

Use this to set the low pressure alarm set-point.

```
- PRESSURE SETUP -
LABEL: OIL
UNIT: BAR
SPAN: 10.0 BAR
TOPSCALE: OFF
ALARM LOW: ON
ALARM LOW: 1.5
ALARM HIGH: ON
```

Select whether to use the high pressure alarm.

```

- PRESSURE SETUP -
UNIT: BAR
SPAN: 10.0 BAR
TOPSCALE: OFF
ALARM LOW: ON
ALARM LOW: 1.5
ALARM HIGH: ON
ALARM HIGH: 8.0

```

Use this to set the high pressure alarm set-point.

4.9 Temperature Setup

```

- TEMP SETUP -
*** DONE ***
TEMP DISP: ON
SENDER: VDO
LABEL: OIL
UNIT: °C
SPAN: 150°C
TOPSCALE: OFF

```

Move the highlight over the “DONE” menu option and press the rotary button to return to the main menu.

```

- TEMP SETUP -
*** DONE ***
TEMP DISP: ON
SENDER: VDO
LABEL: OIL
UNIT: °C
SPAN: 150°C
TOPSCALE: OFF

```

Select whether to use the the temperature sender or not. Switching it to off will disable the temperature display on the main screen.

```

- TEMP SETUP -
*** DONE ***
TEMP DISP: ON
SENDER: VDO
LABEL: OIL
UNIT: °C
SPAN: 150°C
TOPSCALE: OFF

```

Select what type of sender you are using. Select “VDO” a VDO resistive sender, “MGL” for a MGL NTC resistive temperature sender, LM335 for a MGL precision temperature sender or “USER” for a custom sender. The E-1 has a built in linearization curve for a standard 50°C to 150°C VDO resistive sender as well as for the MGL NTC resistive sender.

If the sender type is set to “User”

```

- CH 1 SETUP -
*** DONE ***
MODE: TEMP
SENDER: USER
CALIBRATE SENDER
LABEL: OIL
UNIT: °C
SPAN: 150°C

```

```

- CH 1 SETUP -
*** DONE ***
MODE: TEMP
SENDER: USER
CALIBRATE SENDER
LABEL: OIL
UNIT: °C
SPAN: 150°C

```

If the sender type is set to “USER”, then use this menu option to calibrate your temperature sender. See section 4.10 for more information.

If the sender type is set to “LM335”

```

- TEMP SETUP -
*** DONE ***
TEMP DISP: ON
SENDER: LM335
LM335: +0 22°C
LABEL: OIL
UNIT: °C
SPAN: 150°C

```

```

- TEMP SETUP -
*** DONE ***
TEMP DISP: ON
SENDER: LM335
LM335: +0 22°C
LABEL: OIL
UNIT: °C
SPAN: 150°C

```

If the sender type is set to LM335, then use this menu option to calibrate your LM335 precision temperature sender. If recalibration is required then adjust the value using the up/down keys or the rotary control until the temperature matches the reference ambient temperature. Please note that the LM335 can only be calibrated in degrees Celcius irrespective if the E-1 is setup to display temperature in Fahrenheit.

Menu options for all sender types

```

- TEMP SETUP -
*** DONE ***
TEMP DISP: ON
SENDER: VDO
LABEL: OIL
UNIT: °C
SPAN: 150°C
TOPSCALE: OFF

```

Choose one of a selection of labels to suit your temperature input so you can identify it easily.

```

- TEMP SETUP -
*** DONE ***
TEMP DISP: ON
SENDER: VDO
LABEL: OIL
UNIT: °C
SPAN: 150°C
TOPSCALE: OFF

```

Select whether you want the temperature to be displayed in degrees Celcius (°C) or in degrees Fahrenheit (°F).

```

- TEMP SETUP -
*** DONE ***
TEMP DISP: ON
SENDER: VDO
LABEL: OIL
UNIT: °C
SPAN: 150°C
TOPSCALE: OFF

```

Set the range of the temperature sender. This is the maximum that the bargraph display will go to.

```

--- TEMP SETUP ---
*** DONE ***
TEMP DISP: ON
SENDER: UDO
LABEL: OIL
UNIT: °C
SPAN: 150°C
TOPSCALE: OFF
    
```

This allows the user to zoom into the top half of the bar graph resulting in a higher display resolution. This option set to “ON” is recommended.

```

--- TEMP SETUP ---
TEMP DISP: ON
SENDER: UDO
LABEL: OIL
UNIT: °C
SPAN: 150°C
TOPSCALE: OFF
ALARM LOW: ON
    
```

Select whether to use the low temperature alarm.

```

--- TEMP SETUP ---
SENDER: UDO
LABEL: OIL
UNIT: °C
SPAN: 150°C
TOPSCALE: OFF
ALARM LOW: ON
ALARM LOW: 70
    
```

Use this to set the low temperature alarm set-point.

```

--- TEMP SETUP ---
LABEL: OIL
UNIT: °C
SPAN: 150°C
TOPSCALE: OFF
ALARM LOW: ON
ALARM LOW: 70
ALARM HIGH: ON
    
```

Select whether to use the high temperature alarm.

```

--- TEMP SETUP ---
UNIT: °C
SPAN: 150°C
TOPSCALE: OFF
ALARM LOW: ON
ALARM LOW: 70
ALARM HIGH: ON
ALARM HIGH: 135
    
```

Use this to set the high temperature alarm set-point.

4.10 Calibrating the user defined pressure and temperature sender

```

--- PRESSURE: 0 ---
*** DONE ***
POINTS: 10
DISPLAY 1: 1.0
ADC 1: 1000
DISPLAY 2: 2.0
ADC 2: 0900
DISPLAY 3: 3.0
    
```

- Enter the number of points that you want to calibrate.
- Enter the display reading that you want to show when the sender is at that actual display reading.
- Enter the ADC (analog to digital converter) reading that corresponds to this display reading. The ADC reading is shown at the top of the calibration menu if you are applying the actual stimulus from the temperature or pressure sender. You can also manually enter this value if the ADC value is known or pre-calculated.
- Continue entering display and ADC values until all the points have been entered.
- Verify the above calibration by checking the temperature/pressure display versus the actual applied sender stimulus.

```

--- TEMP: 0 ---
*** DONE ***
POINTS: 10
DISPLAY 1: 010
ADC 1: 1000
DISPLAY 2: 020
ADC 2: 0900
DISPLAY 3: 030
    
```

4.11 Voltage Setup

```

--- MAIN MENU ---
 VOLTS
SETUP
    
```

Move the highlight over this menu item and press the rotary button to return to the main menu.

```

--- VOLTS SETUP ---
*** DONE ***
VOLT ALARM: ON
LOW ALM: 10.0V
HIGH ALM: 15.0V
    
```

Select whether you want the voltage alarm to be turned on or off.

```

--- VOLTS SETUP ---
*** DONE ***
VOLT ALARM: ON
LOW ALM: 10.0V
HIGH ALM: 15.0V
    
```

```

VOLTS SETUP
*** DONE ***
VOLT ALARM: ON
LOW ALM: 10.00V
HIGH ALM: 15.00V
    
```

Enter the low voltage set-point for when the alarm must be activated. Any voltage below this value will activate the alarm.

```

VOLTS SETUP
*** DONE ***
VOLT ALARM: ON
LOW ALM: 10.00V
HIGH ALM: 15.00V
    
```

Enter the high voltage set-point for when the alarm must be activated. Any voltage above this value will activate the alarm.

5 Engine configurations

The E-1 supports 66 different engine configurations. See the table below.

EGT				CHT				Pressure	Temperature	RPM	Volts
1	2	3	4	1	2	3	4				
X										X	X
	X									X	X
		X								X	X
			X							X	X
				X						X	X
					X					X	X
						X				X	X
							X			X	X
X				X						X	X
X					X					X	X
X						X				X	X
	X			X						X	X
	X				X					X	X
		X		X						X	X
				X				X		X	X
X									X	X	X
	X								X	X	X
		X							X	X	X
			X						X	X	X
				X					X	X	X
					X				X	X	X
						X			X	X	X
							X		X	X	X
X				X					X	X	X

X					X					X	X	X
X						X				X	X	X
	X			X						X	X	X
	X			X						X	X	X
		X		X						X	X	X
X								X		X	X	X
	X							X		X	X	X
		X						X		X	X	X
			X					X		X	X	X
				X				X		X	X	X
					X			X		X	X	X
						X		X		X	X	X
							X	X		X	X	X
X				X				X		X	X	X
X					X			X		X	X	X
X						X		X		X	X	X
	X			X				X		X	X	X
	X			X				X		X	X	X
		X		X				X		X	X	X
			X	X						X	X	X
			X	X						X	X	X
Rotax 912/914 display modes												
X				X							X	X
X					X						X	X
	X			X							X	X
	X				X						X	X
		X		X							X	X
		X			X						X	X
			X	X							X	X
			X	X							X	X

6 Loading Factory default settings

Pressing and holding the F1 and F2 keys simultaneously on power up will cause the E-1 to load preprogrammed factory default settings. The following screen will be displayed:

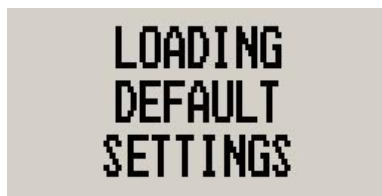

7 Operating the alarms

If the alarm is activated, the corresponding item on the display will flash. At the same time the externally available alarm switch will close. The switch will remain closed until any button is pressed to acknowledge the alarm or until the condition(s) that activated the alarm no longer exist. The alarm output can be used to switch an external alarm indicator. The external alarm switch is an open collector transistor switch to ground with a maximum rating of 0.5A DC. It is possible to wire the alarm contacts of several Stratomaster instruments in parallel should this be desired. To avoid false activation of the alarms, the alarm function is only active 10 seconds after the instrument has powered up.

8 Cleaning

The unit should not be cleaned with any abrasive substances. The screen is very sensitive to certain cleaning materials and should only be cleaned using a clean, damp cloth.

Warning: The E-1 is not waterproof. Serious damage could occur if the unit is exposed to water and/or spray jets.

9 E-1 Specifications

Operating Temperature Range	-10°C to 50°C (14°F to 122°F)
Storage Temperature Range	-20°C to 80°C (-4°F to 176°F)
Humidity	<85% non-condensing
Power Supply	8 to 30Vdc SMPS (switch mode power supply) with built in 33V over voltage and reverse voltage protection
Current Consumption	approx. 47mA @ 13.8V (backlight on) 16mA @13.8V (backlight off)
Display	128x64 graphic LCD display. Contrast and backlight is user configurable, green/yellow backlight
Dimensions	see Velocity series dimensional drawing
Enclosure	3.125" ABS, black in color, front or rear mounting
Weight	Approx. 242 grams
Alarm contact current rating	Open collector transistor switch to ground. Maximum rating 0.5A DC
Non-volatile memory storage	100000 write cycles
RPM	
Rev counter input	Range: 0-20000 RPM. Minimum signal for stable display: 5Vpp. Fully A/C coupled, maximum voltage +/- 40V RF noise filter plus Schmitt-trigger based input
EGT / CHT Thermocouples	
Thermocouples	K-type, J-type and E-Type
Measurement range	J-Type: -210°C to 1200°C (-346°F to 2192°F) K-Type: -270°C to 1370°C (-454°F to 2498°F) E-Type: -270°C to 900°C (-454°F to 1652°F)
Technology	Fully cold junction compensated using precision internal temperature reference, built in thermocouple linearization tables
Measurement accuracy	+/- 5 degrees typical over full temperature range, subject to quality of probe used.
Inputs	Differential, can use grounded and isolated probes
Common mode voltage range	-2V to +3V
Temperature Sender	
Temperature sensors	<p>VDO Resistive Senders: Standard 50°C to 150°C resistive temperature sender.</p> <p>MGL NTC Resistive Sender: Echlin TS920SA automotive temperature sender</p> <p>MGL Precision LM335 semiconductor: Based on National</p>

	<p>Semiconductor LM335 temperature sensor</p> <p>User defined senders: The E-1 has a user sender calibration feature that can be customized for senders not listed above</p>
--	---

Pressure Sender

<p>Pressure sensors</p>	<p>VDO Resistive Sender: Standard VDO resistive pressure senders. VDO pressure senders used to measure fuel pressure require the fuel isolation kit available from VDO.</p> <p>Rotax 4-20mA Sender: The E-1 supports the 4-20mA pressure sender as used in Rotax 912/914 engines.</p> <p>The 4-20mA pressure sender uses pin 8 (Yellow) on the DB9 connector.</p> <p>0-5V Output Pressure Senders: e.g. UMA that outputs a 0-5V signal.</p> <p>The E-1 has built in linearisation curves for the UMA T1EU07, T1EU35, T1EU70A, T1EU70, T1EU100 and T1EU150</p> <p>User defined senders: The E-1 has a user sender calibration feature that can be customized for senders not listed above.</p>
--------------------------------	---

Supply Voltage Measurement

Range	8 to 30V DC
Resolution	0.1V

10 Installation

10.1 General Connection Diagram

The use of an external 1A fuse is recommended. Connect the supply terminals to your aircrafts power supply. The E-1 can be used on both 12V and 24V without the use of any pre-regulators. Ensure that the supply voltage will not drop below 8V during operation as this may result in incorrect displays.

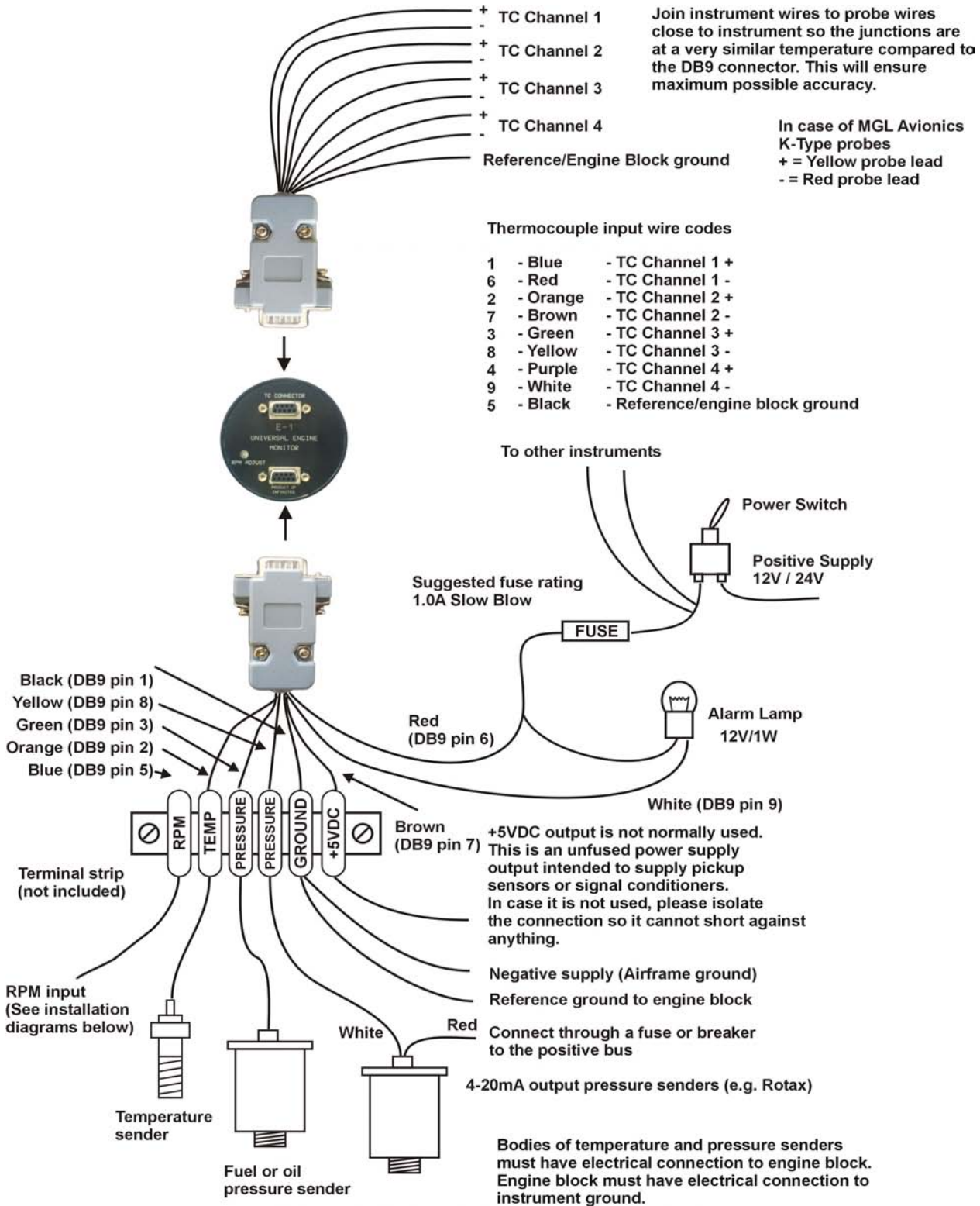

10.2 EGT/CHT Installation

The E-1 provides for up to 4 thermocouple inputs for use with EGT and CHT probes. K, J as well as E type probes can be used. K types are used for EGT probes while CHT probes can either be J or K type. E-type probes are seldom used. Probe types are selected in the “EGT SETUP” and “CHT SETUP” menus of the E-1.

Important: Incorrect selection of probe type will lead to an incorrect temperature display.

The E-1 will accept both grounded and isolated thermocouple probes. Your only consideration in case of the more common grounded configurations is that you need to ensure that the thermocouple mounting position (exhaust flange, etc.) is at the same electrical potential as the negative supply line of the E-1.

The thermocouple amplifier is a precision device providing full cold junction compensation. In addition the amplifier measures and corrects for its own errors. This results in a very accurate measurement provided that you install high quality probes. Here are some guidelines:

EGT Probes: Select probes that are made from 316 stainless steel and that use glass-fiber insulated conductors. Teflon insulated conductors as found in many cheap probes introduce errors as the insulation melts moving the measuring point towards the mounting bolt which transfers a lot of heat to the exhaust material. This results in under reading probes. Stay away from probes that use simple plastic heat shrink sleeving – it does not last. Choose probes that use a generous amount of stainless steel spring as strain relief. The bolt itself should be stainless steel as well or it will rust very quickly.

CHT Probes: These are made from washers to fit spark-plug bases. Temperatures are considerably lower so most thermocouple cables will work without problems. The biggest area of concern should be the connection of the thermocouple cable to the washer. This often breaks after the spark plug has been changed a few times. Choose a probe that is suitably reinforced at this point for a long and trouble free life.

EGT and CHT probes supplied by MGL Avionics are of the highest quality. We recommend that you consider using our probes if at all possible.

Warning: Four stroke engines produce much hotter exhaust gases compared to two stroke engines. Do not use EGT probes made from lower grade stainless steel (for example 310), these probes will not withstand the high temperatures and can fail as the metal gets very soft at 800 degrees C. Many four strokes (such as the Rotax 912) will produce exhaust gases of up to 850 degrees C.

Important installation note:

EGT and CHT probes use wire made from iron and other basic metals. As a result these probes are not able to withstand much flexing of the wire due to engine vibration. Avoid making nice looking coils or similar constructions that will result in excessive vibration or flexing of the wire. Route the cables from the probe points tightly along suitable engine mounting points eliminating any chance of unnecessary wire flexing during engine operation.

10.3 Extending leads of thermocouple probes

Thermocouple leads as used with the EGT and CHT probes can be extended either with ordinary copper cable or with special K-Type extension cable. The choice of either depends on your desired accuracy. If it is possible in your installation to ensure that both ends of a copper extension cable will be at the same temperature (or very close), then it is quite possible to use the copper cable. In most open-air installations this will be the case. Should this not be possible or you require best possible accuracy at all times, you can obtain a special K-type extension cable. This cable is made from the same metals as your probes cable and uses ordinary plastic sleeving as insulation. In either case, ensure that the cable is not routed close to sources of electromagnetic interference of any kind. The voltages present in this cable are very small and are subject to changes applied by external fields. This can lead to false temperature indications. You can check your installation by using a hand-held transmitter, such as an air band radio. If you transmit a signal, no change in temperature reading should occur.

10.4 Temperature senders

Four types of temperature senders can be fitted:

VDO Resistive senders: A standard 50°C to 150°C VDO resistive automotive sender can be used.

MGL NTC resistive senders: A suitable sender with the same thread used by Rotax can be obtained from MGL Avionics (manufacturer Echlin).

Most NTC senders require a single wire connected as shown. The sender is grounded via the engine block. The ground terminal of the gauge input should be connected to the engine block. Some NTC senders have two wires. In this case it is not required that the sender housing itself is connected to the engine block. Wire the second wire to the reference ground terminal.

MGL Precision senders (National Semiconductors LM335): These are senders containing a semiconductor temperature measurement device. They can be used for water or oil temperature. These senders are available in two types: an encapsulated version with a brass housing suitable for Rotax thread; a second uncommitted version contains only the sensor itself. This can be conveniently mounted inside an existing sender housing after you remove the original insides of the sender. This is intended to give you a solution for unusual or difficult to obtain senders.

Connect the Black wire to ground, the Red or green wire to the temperature channel input.

User defined senders: The E-1 has a user sender calibration feature that can be customized for senders not listed above.

Connect the temperature sender to the orange (Pin 2) on the DB9 connector

10.5 Pressure senders

Four types of pressure senders can be fitted

VDO Resistive senders: Most pressure senders used for engines are resistive types. These tend to have a very low resistance at low pressures and a high resistance at their maximum pressure output. The resistance is approximately linear with pressure. The E-1 supports both increased resistance with pressure as well as decrease resistance with pressure types. The E-1 allows you to choose the pressure sender type as described in the relevant section of this manual. Most automotive types have resistance ranges from 10 to 400 ohms. For example: the oil pressure sender as installed in a Rotax 912/914 engine has approx. 10 Ohms at 0 Bar and 180 Ohms at 10 bars.

Connect your VDO/resistive sender to the green (Pin 3) wire on the DB9 connector.

4-20mA Pressure Senders: The E-1 supports the 4-20mA pressure sender as used in Rotax 912/914 engines

Connect your VDO 4-20mA senders white wire to the yellow wire on the DB9 connector (Pin 8).

0-5V output senders: e.g. UMA that can be used with the E-1 are those types that have their maximum output voltage of 5V at their maximum pressure output. The E-1 has built in linearisation curves for the UMA T1EU07, T1EU35, T1EU70A, T1EU70, T1EU100 and T1EU150

Connect your UMA/Voltage output sender to the green (Pin 3) wire on the DB9 connector.

User defined senders: The E-1 has a user sender calibration feature that can be customized for Resistive, 4-20mA as well as Voltage output senders.

10.6 Senders that are grounded in the engine block

Single wire senders require that their mounting arrangement (thread) has a very good electrical contact with the engine block. Avoid the use of any sealant or tapes as these may cause a bad electrical connection. Further to this it is very important that the engine block has a good electrical connection to the negative supply terminal of the E-1. Any voltage drop caused by other equipment on the ground wire will cause incorrect readings. The best way to ensure a good connection is to wire a single connection between the E-1 ground terminal (any of these terminals) and the engine block. Do not wire this anywhere else and do not allow any other equipment to use this wire as a current return path.

10.7 RPM Installation

After you have connected the rev counter terminal to the signal source you need to set the number of pulses per revolution under the "RPM SETUP" menu. The calibration itself depends on your engine type and what kind of signal you are using. Typical sources are:

- Magneto coils (suitable signal at the kill switch)
- Primary (low voltage) side of ignition coil, at contact breaker or electronic ignition module
- RPM counter output of electronic ignition systems (for example Bosch Motronic)
- RPM pickup devices such as hall-effect sensors on flywheels etc.

Please see the engine connection diagrams for the RPM connection to the E-1. The E-1 input is quite universally usable. The rev counter input on the E-1 can be used with signals from about 5Vpp to as much as 100Vpp and the input is AC coupled for easy installation. A noise filter is included that results in the input ignoring any noise signals as long as this is below the detection threshold of about 2.5Vpp. The input impedance of the rev counter input is approximately 10Kohm. You can use series resistors as well as load resistors for applications that have unusual signals.

For installations such as with the Rotax DCDI two-stroke engines, the rev counter input is simply connected to the grey rev counter wire from the engine. These engines produce six pulses per rev (set this up in the relevant menu item). Most engines produce 0.5, 1, 2 or 6 pulses per revolution. This needs to be setup in the "RPM SETUP" menu item.

Please note: The +5V supply line is unprotected and intended only for the supply of a hall-effect, optical or gear tooth sensors. Connecting any voltages (such as the 12V supply) to this line could destroy the instrument. The +5V line may supply currents of up to 30mA. Should your sensor require greater currents you must supply it from another source.

Please note: It is essential that a single wire be connected from the minus terminal of the instrument to the engine block. This wire must not be used to share currents with other electrical users as this can affect accuracy of readings.

10.8 Adjusting RPM sensitivity



**RPM Sensitivity
adjustment screw**

The E-1 has a RPM sensitivity adjustment trimmer as shown in the picture. Adjust this trimmer using a small screwdriver such that you get stable RPM readings over the entire rev band of your engine. If your sensitivity is too high, you may get unstable RPM readings (usually at higher RPM as electrical noise in the ignition system increases). If the sensitivity is too low the RPM reading may remain at zero. Fully clockwise = maximum sensitivity.

10.9 Connecting the E-1 RPM input to automotive engines

Conventional contact breaker ignition system

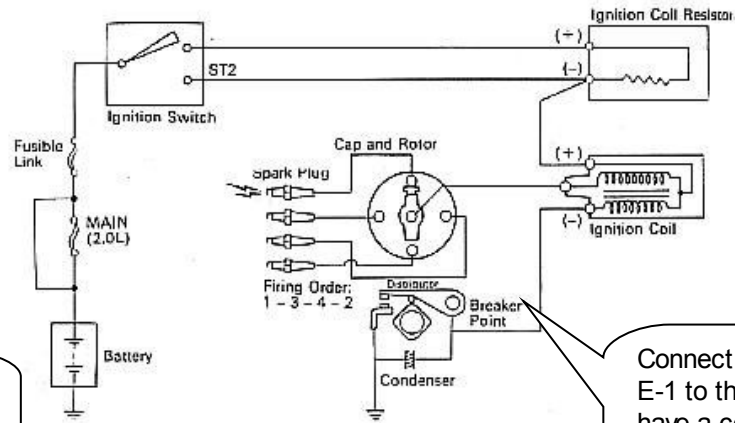

Use the tachometer line if your system has such a signal

Connect rev counter input of E-1 to this line. Ensure you have a connection from the E-1 ground to the engine block.

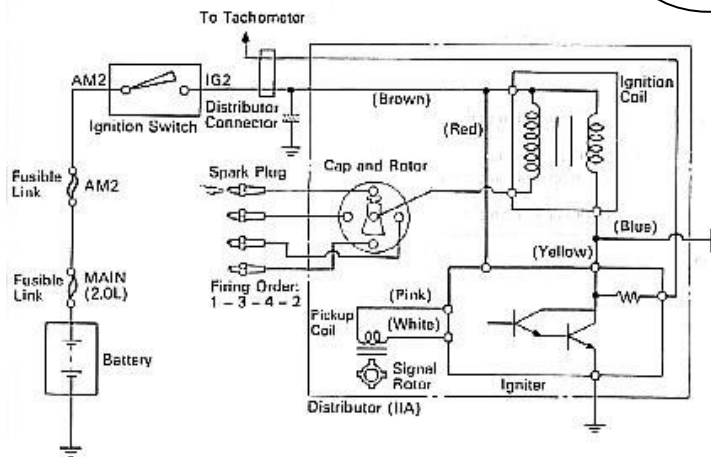

Connect rev counter input of E-1 to this line. Ensure you have a connection from the E-1 ground to the engine block.

Electronic ignition system with conventional ignition coil

10.10 Connecting a Bendix magneto as a RPM source

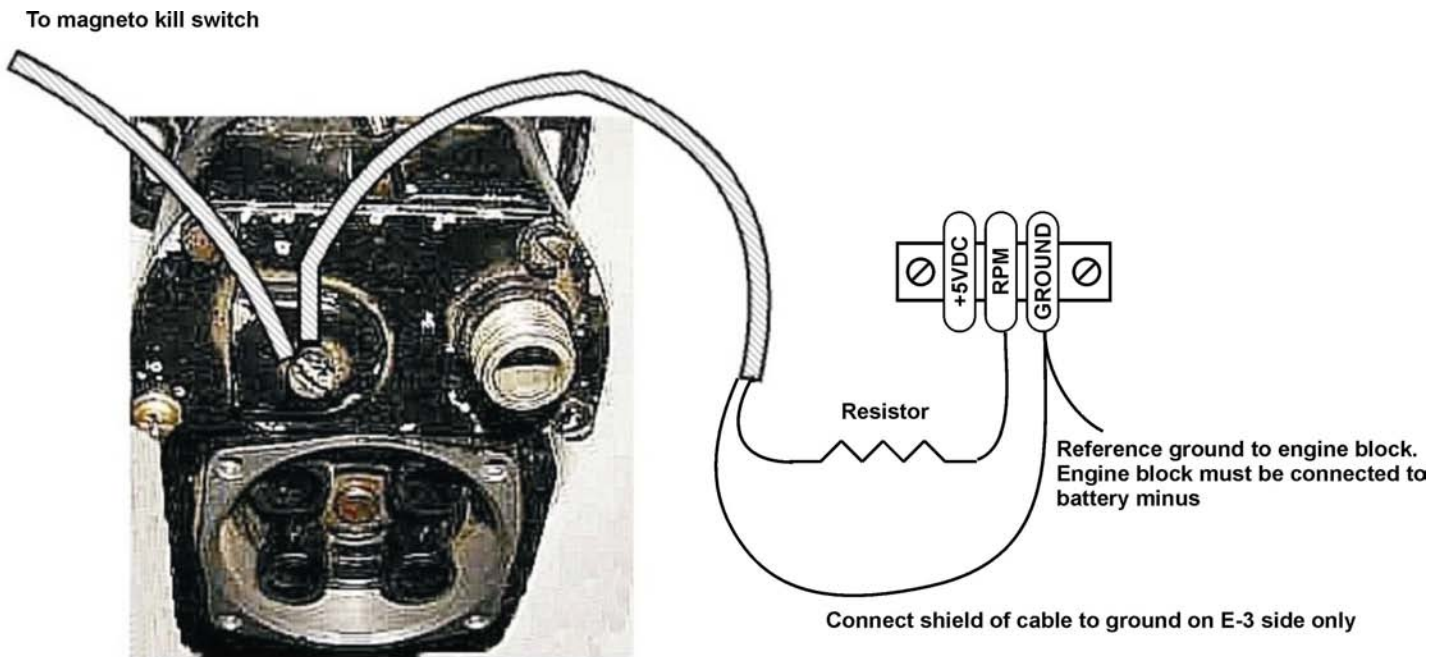

Typical connection to a Bendix P-Terminal.
This terminal will have a wire going to your
magneto kill switch or starter switch. Please
note that various kinds of terminals are used
on the many different types of Bendix magnetos

The above drawing shows the connection required if you would like to connect a magneto as RPM source. Shown is a typical Bendix magneto as used on Lycoming and other aircraft engines. You should find a wire connected to a terminal on the magneto that originates from your magneto kill switch (or starter switch). The terminal is often referred to as a "P-terminal". Connect a wire as shown and connect this to the RPM input of the E-1. We strongly recommend that a resistor is inserted into your wire as shown. A good value would be 10.000 ohms (10K). A normal 1/4 W resistor is just fine. The above circuit can also be used on other magneto systems such as found on Jabiru and similar engines.

The supplied 220 Ohm ballast resistor should not be used on the above installation.

10.11 Various other pickup/sensor installation possibilities

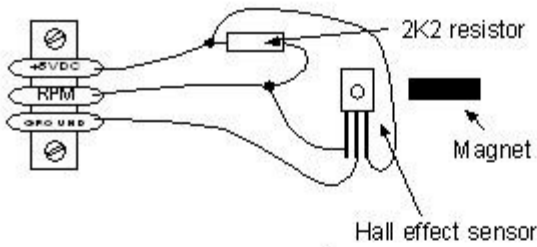

Typical hall effect sensor installation detects the passing of a magnet suitably fixed to prop flanges or shafts.

Magnetic pickup with Hall effect sensor

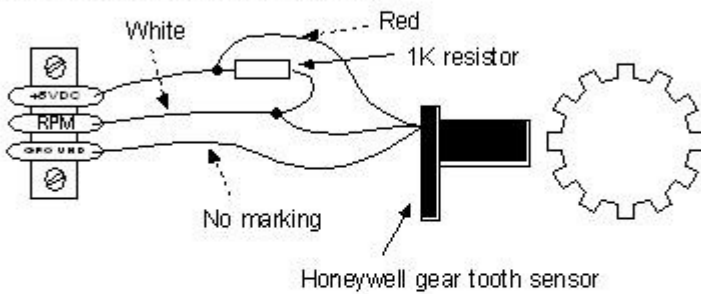

The gear tooth sensor is a popular pickup used on the pre-rotation gear of a gyro plane (rotor speed indication).

Magnetic pickup with active gear tooth sensor

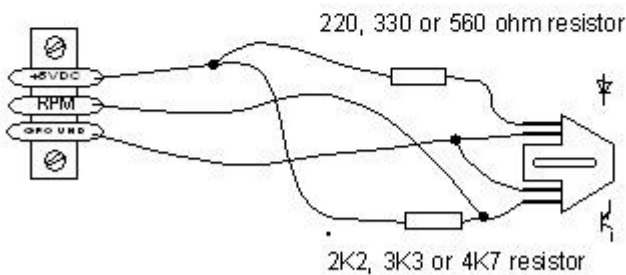

The optical reflective pickup can provide a simple means of contactless RPM sensing in difficult installations.

Optical, reflective sensor

10.12 Connection diagram for a Rotax 503 or 582 engine

This diagram shows EGT, CHT and water temperature sender locations and wiring based on a Rotax 582. This is a water cooled engine so CHT senders should be viewed as optional. For a Rotax 503 or similar air-cooled installation, proceed similar but omit the water temperature sender and wiring.

Ground wire connects to a suitable ground point on engine block.
 Note: Engine block needs to be electrically connected to negative terminal of aircraft battery.

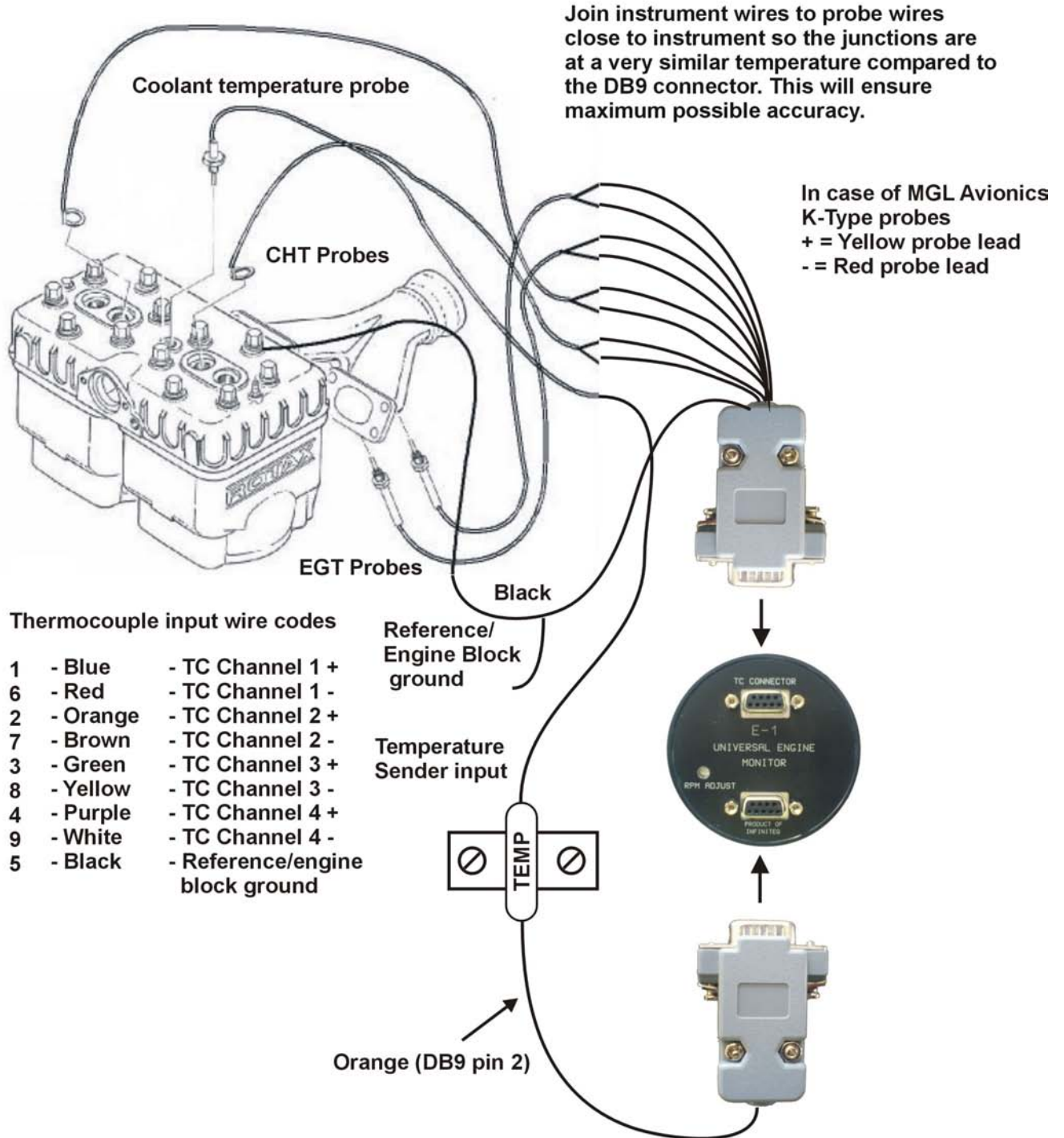

Other wiring not shown, please refer to the general connection diagram

Please note that the ground connection (black wire) from the E-1 must be connected to the engine block as shown. Select a suitable point on your engine block for this connection. The engine block itself needs to be connected to the negative supply, in all cases this should be a direct connection to your batteries minus terminal. This should be a thick copper cable with a very low resistance and it needs to be as short as possible. This requirement is even more severe if you are using electric start as the very considerable currents required by the starter motor will be using this connection.

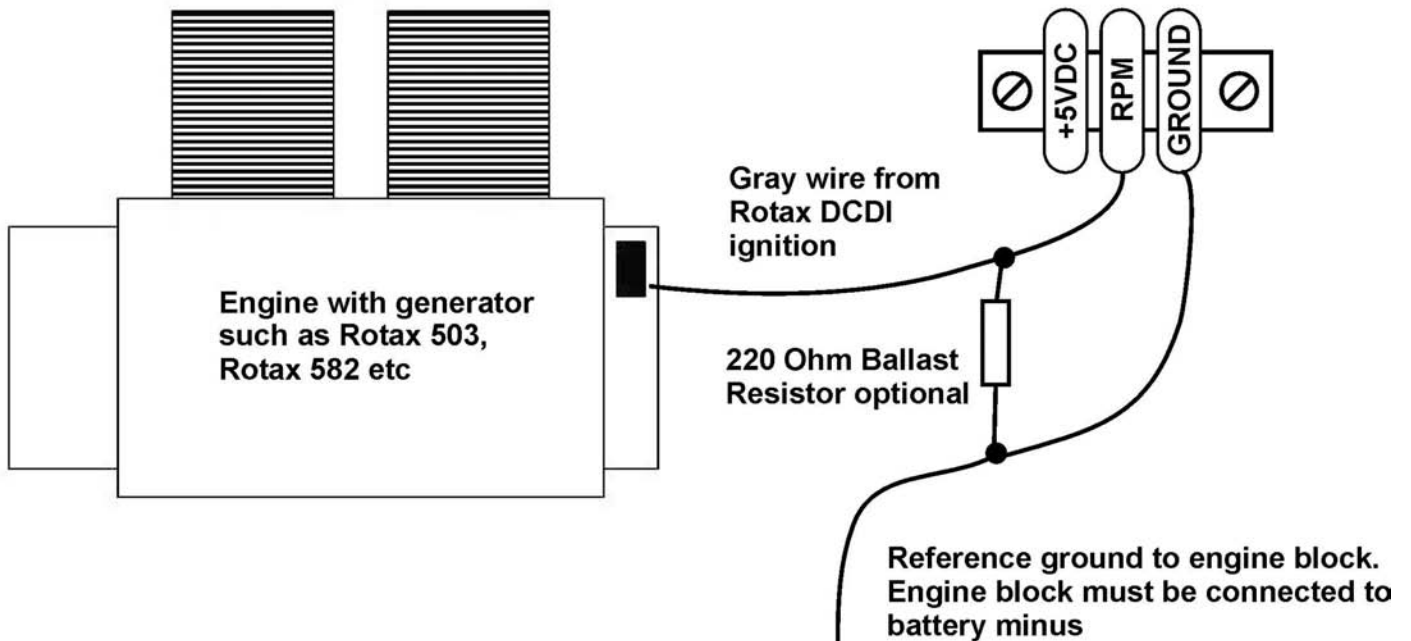

For this engine we recommend that you use the supplied 220 ohm ballast resistor. Select a value of 6.0 for pulses per revolution under the "RPM SETUP" menu.

Note: Some Rotax engines may require that a 220 ohm ballast resistor is fitted between the rev counter input and the ground terminal. This resistor should be fitted if you cannot obtain stable RPM throughout the range regardless of any setting of the rev counter sensitivity adjustment.

10.13 Connection diagram for a Rotax 912 or 914 engine

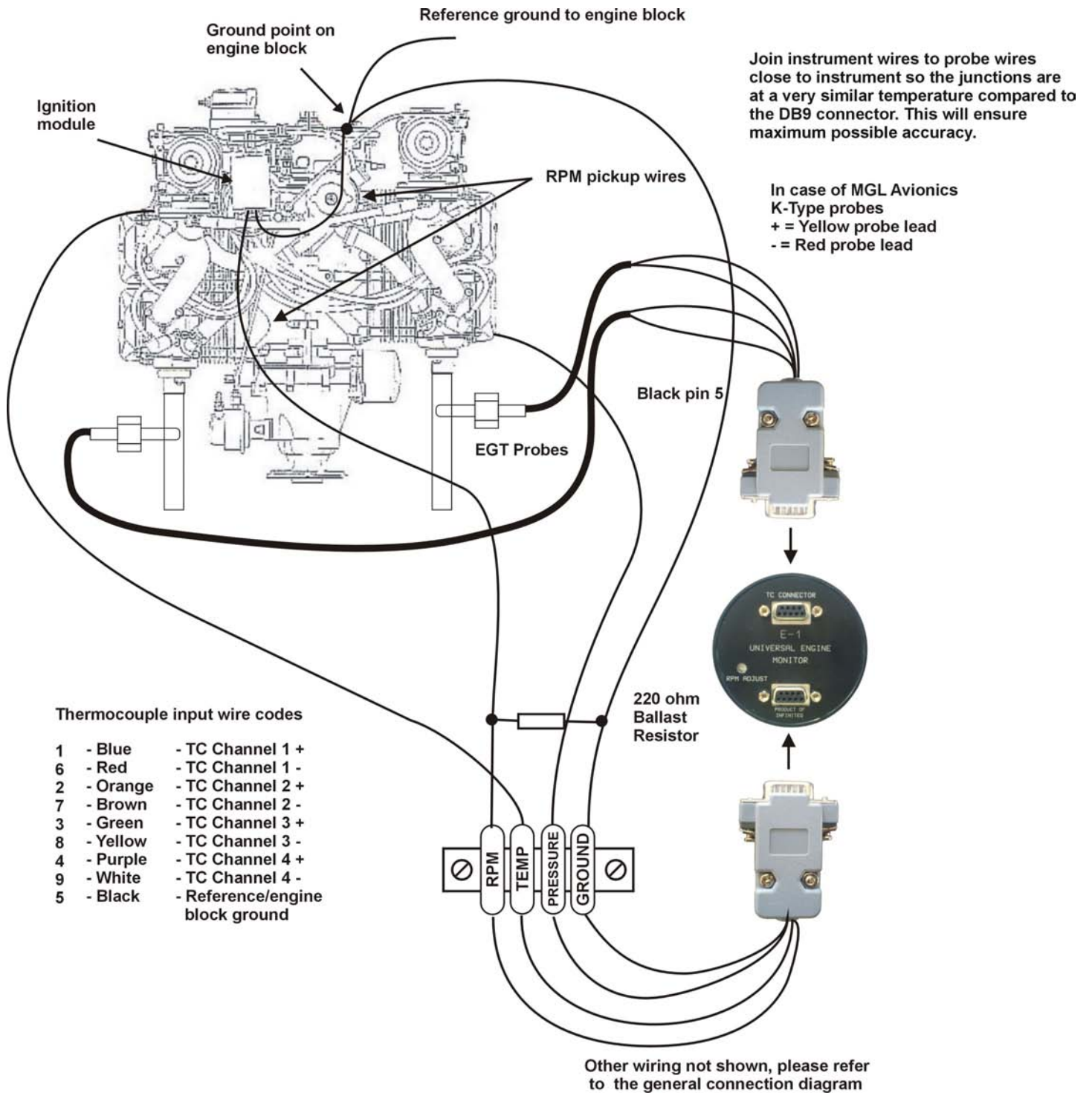

This installation assumes that two EGTs are used (you can install up to four EGT, one for each cylinder). This installation makes use of the two built in NTC type cylinder head temperature senders.

Connect the rev counter wires (blue/yellow and white/yellow) as follows: One of the two wires needs to be connected to ground (engine block), the other to the RPM counter input. For this engine we recommend that you use the supplied 220 ohm ballast resistor. Select a value of 1.0 for pulses per revolution under the "RPM SETUP" menu.

10.14 E-1 DB9 Cable connections

Main Connector (Bottom DB9 Connector)

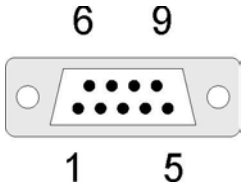

DB 9 Pin	Color	Function
1	Black	Ground
2	Orange	Temperature Sender input
3	Green	Pressure Sender input (Resistive and 0-5V)
4	NC	Airtalk communication (Not connected) Used for firmware upgrading
5	Blue	RPM Input
6	Red	8-30Vdc power
7	Brown	+5VDC Power Out
8	Yellow	Pressure Sender input (4-20mA)
9	White	Alarm Output

Thermocouple (EGT/CHT) input connector (Top DB9 connector)

In case of MGL Avionics K-Type probes + = Yellow probe lead, - = Red probe lead

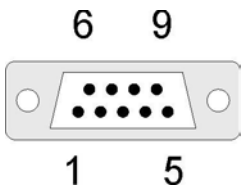

DB 9 Pin	Color	Function
1	Blue	TC Channel 1 +
2	Orange	TC Channel 2 +
3	Green	TC Channel 3 +
4	Purple	TC Channel 4 +
5	Black	Reference ground (connect to engine block)
6	Red	TC Channel 1 -
7	Brown	TC Channel 2 -
8	Yellow	TC Channel 3 -
9	White	TC Channel 4 -

10.15 UMA Voltage output pressure sender (0 to 5V output)



Pinout:

- White/Red: +12V
- White: Signal
- White/Blue: Ground
- Shield: Ground

10.16 VDO 4-20mA Pressure sender

DIMENSIONS for reference only mm (in)

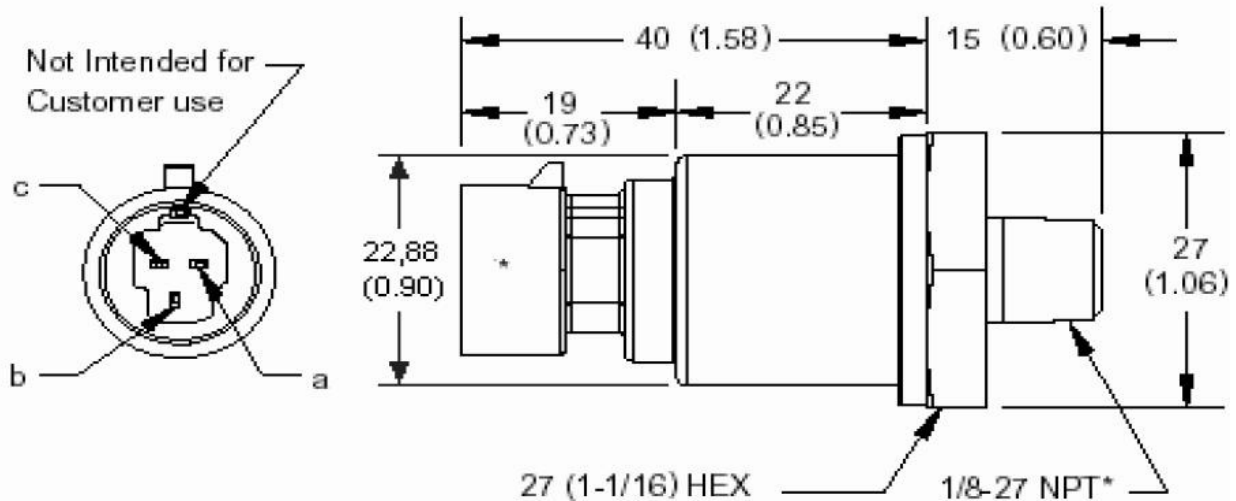

The sensor cable is approximately 3m long and has 3 leads. The black lead is not to be connected and has no function. The Red lead from the sensor has to be connected to the positive bus via a fuse or circuit breaker. The white lead (Output signal) has to be connected directly to the TP-2 Yellow wire (Pin 8).

11 Warranty

This product carries a warranty for a period of one year from date of purchase against faulty workmanship or defective materials, provided there is no evidence that the unit has been mishandled or misused. Warranty is limited to the replacement of faulty components and includes the cost of labor. Shipping costs are for the account of the purchaser.

Note: Product warranty excludes damages caused by unprotected, unsuitable or incorrectly wired electrical supplies and/or sensors, and damage caused by inductive loads.

12 Disclaimer

Operation of this instrument is the sole responsibility of the purchaser of the unit. The user must make themselves familiar with the operation of this instrument and the effect of any possible failure or malfunction.

This instrument is not certified by the FAA. Fitting of this instrument to certified aircraft is subject to the rules and conditions pertaining to such in your country. Please check with your local aviation authorities if in doubt. This instrument is intended for ultralight, microlight, homebuilt and experimental aircraft. Operation of this instrument is the sole responsibility of the pilot in command (PIC) of the aircraft. This person must be proficient and carry a valid and relevant pilot's license. This person has to make themselves familiar with the operation of this instrument and the effect of any possible failure or malfunction. Under no circumstances does the manufacturer condone usage of this instrument for IFR flights.

The manufacturer reserves the right to alter any specification without notice.

Other instruments in the *Stratomaster Velocity* series

ALT-3	Encoding aviation altimeter and Vertical speed indicator (VSI)
ALT-4	Encoding aviation altimeter with Serial RS232 & Parallel Gillham code output
ASI-3	Airspeed indicator (ASI) with automatic flight log
ASX-2	Encoding aviation altimeter and Airspeed indicator (ASI)
AV-2	Artificial horizon and magnetic compass indicator
E-1	Universal engine monitor
FLIGHT-2	Primary Flight instrument
FF-3	Fuel Computer (single or dual fuel tanks)
GF-2	+/-10G tilt compensated dual range G-force meter
MAP-2	Manifold pressure and RPM Indicator
ROTOR-1	Dual Rotor / Engine tachometer
RTC-1	Aviation real time clock (RTC), outside air temperature (OAT) and Voltage display
RV-3	Universal engine / Rotor RPM Indicator
TC-2	4-Channel thermocouple (EGT/CHT) indicator
TC-3	12-Channel thermocouple (EGT/CHT) indicator
TP-2	Universal temperature and pressure gauge