

FF-1

Fuel management computer for
single or dual fuel tanks

Operating Manual – English 1.10



Introduction

The FF-1 fuel management computer is a 2 1/4" instrument intended for efficient monitoring of fuel related information for single or dual fuel tanks onboard small aircraft and related applications.

The FF-1 unit can connect to one or two fuel flow senders, one or two fuel level senders or both. Full functionality is available with both senders or only with a fuel flow sender using calculated fuel levels based on fuel usage. Differential fuel flow calculations are also supported for fuel return systems. Fuel injector systems are also supported. Standard automotive fuel level senders can be used, even with odd shaped tanks due to a comprehensive, multi-point calibration system. Most fuel flow senders can be used and the K-factor of the sender can be entered into the system for simple calibration. MGL Avionics supplies a lightweight dual range fuel flow sender that is ideally suited for the FF-1.

In addition, the FF-1 can use the airspeed (via the airtalk cable connected to a Infinity ASI-1/ASX-1, Velocity ASI-3/ASX-2 indicator) or actual ground speed (by using the optional GPS NMEA interface cable connected to a RS232 NMEA enabled GPS receiver) to determine fuel range.

1 Features

- Advanced fuel computer with 17 different modes of operation
- Supports single or dual fuel tanks
- The FF-1 can connect to one or two fuel flow senders, fuel level senders or fuel injectors
- Differential fuel flow calculations are also supported for fuel return systems
- The FF-1 has the ability to connect to an ASI-1/ASX-1 or a NMEA enabled GPS receiver for range based calculations. It can also accept a manually entered estimate cruising speed if an ASX-1/GPS is not available.
- Standard automotive fuel level senders can be used, even with odd shaped tanks due to a comprehensive, multi-point calibration system
- Bilingual support (English and French)
- Standard 2 1/4" aircraft enclosure (can be front or rear mounted)
- Rotary control plus 2 independent buttons for easy menu navigation and user input
- Alarm output as well as a red LED illuminates when the fuel level is below the fuel level alarm value
- Large backlit graphic LCD with adjustable contrast
- Wide input supply voltage range of 8 to 30V DC with built in voltage reversal and over voltage protection for harsh electrical environments
- 1 year limited warranty

2 FF-1 Layout

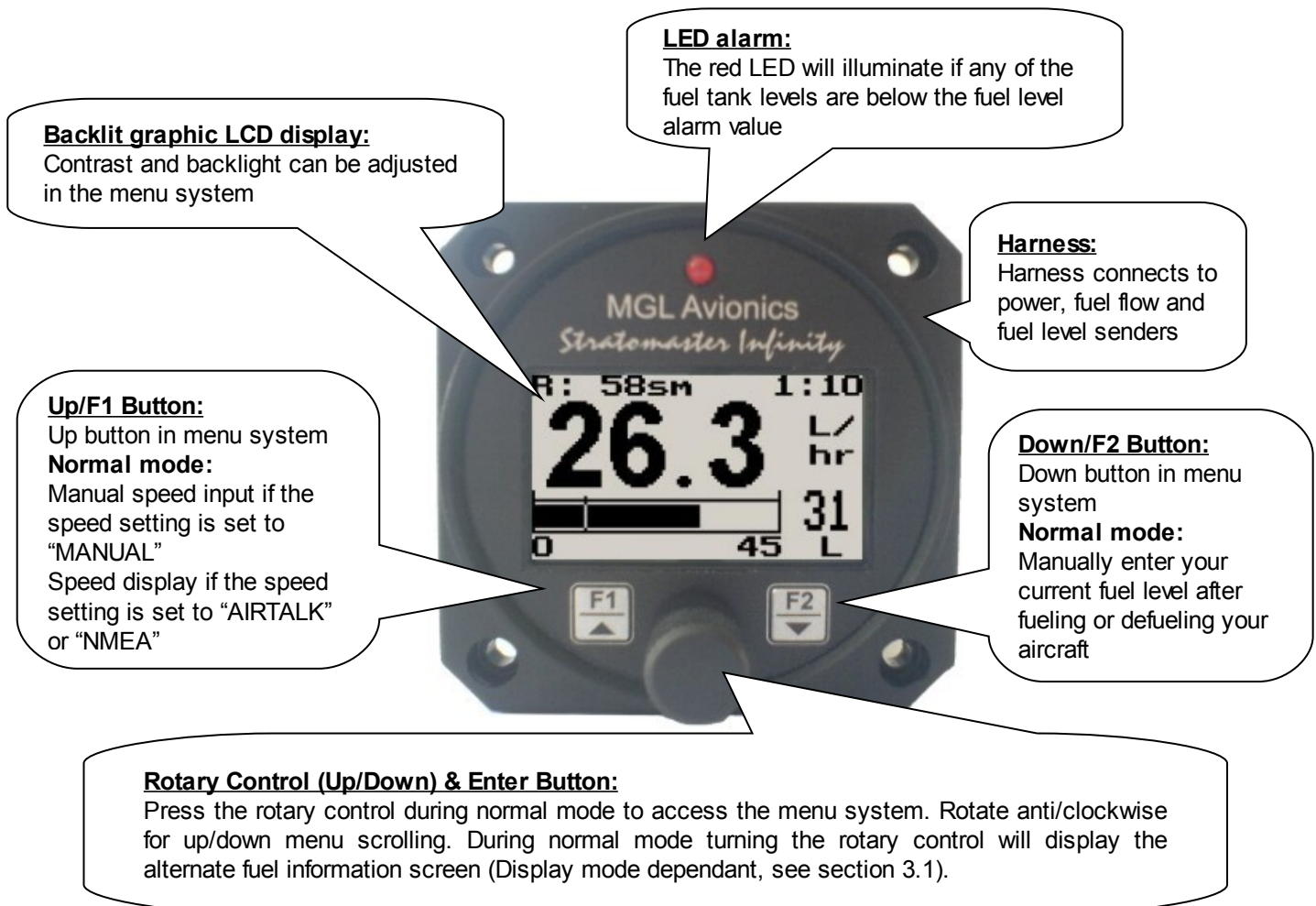

3 Main Displays

The FF-1 has 17 different modes of operation. The display modes can be selected in the fuel setup menu by selecting different configurations of the number of fuel flow/level senders installed. The FF-1 will automatically adjust the display according to these settings.

- 3.1 Single fuel flow and calculated tank level (single tank)
- Single fuel flow and fuel level sender (single tank)
- Differential fuel flow and calculated tank level (single tank)
- Differential fuel flow and fuel level sender (single tank)
- Summed fuel flow and calculated tank level (single tank)
- Summed fuel flow and fuel level sender (single tank)

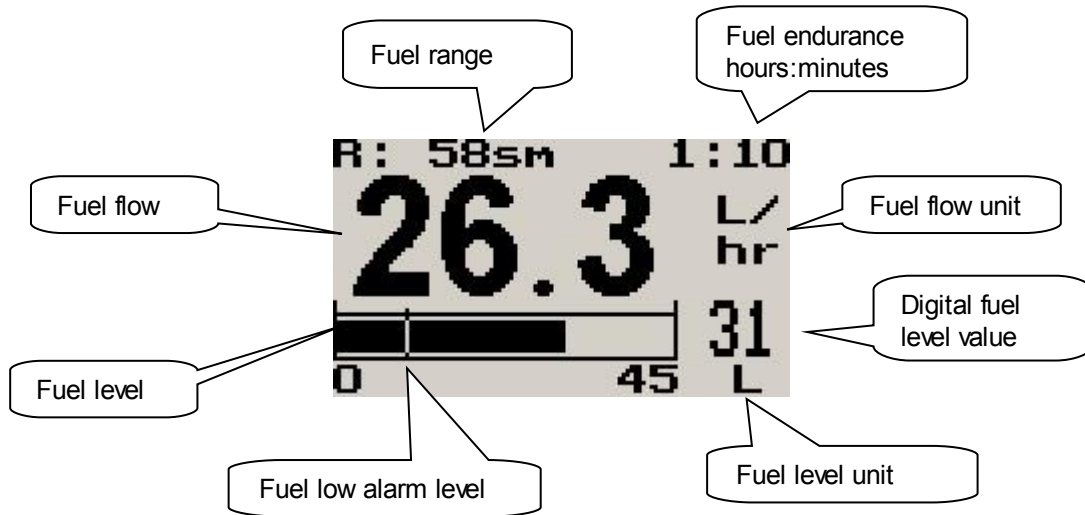

Alternate main screen for the above display modes

This display can be selected by rotating the rotary control.



3.2 Dual fuel flow and calculated tank levels (dual tank) Dual fuel flow and dual fuel level senders (dual tank)

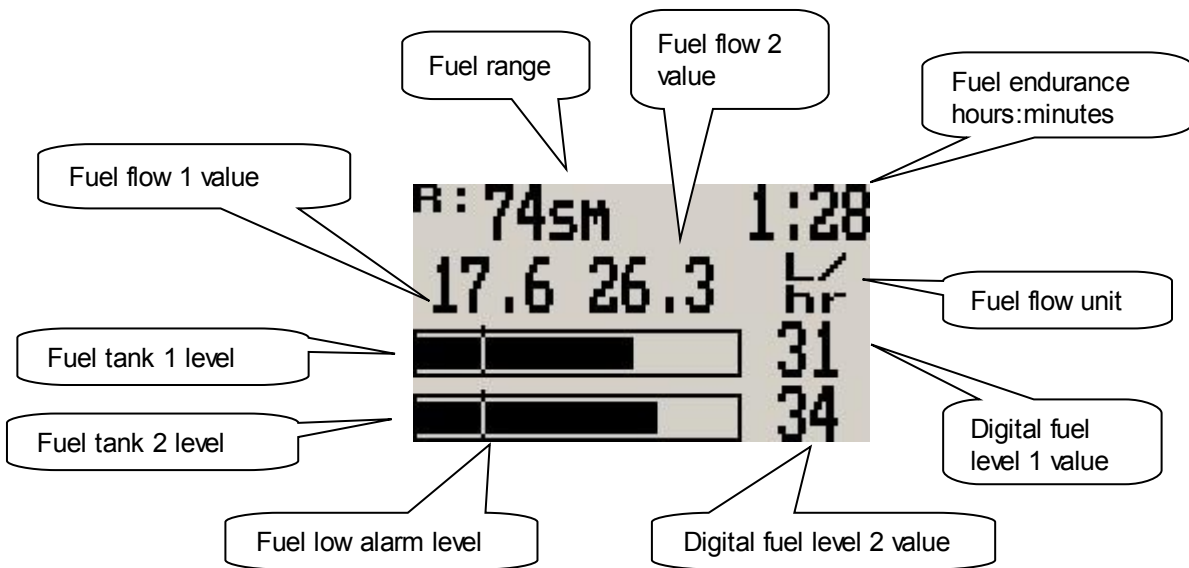

3.3 Single fuel flow and dual fuel level senders (dual tank) Differential fuel flow and dual fuel level senders (dual tank) Summed fuel flow and dual fuel level senders (dual tank)

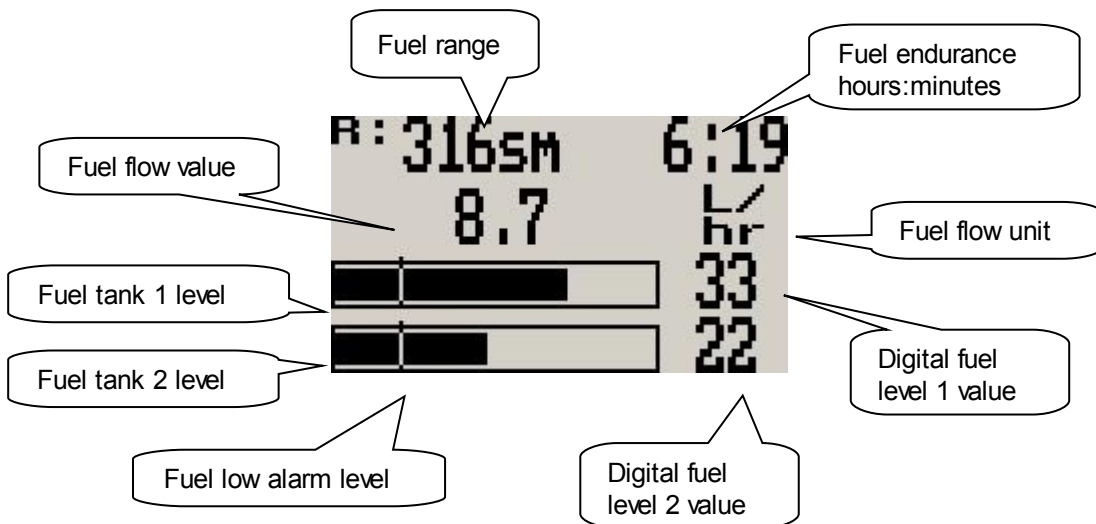

3.4 Single fuel flow only indicator

This mode is displayed if either fuel flow 1 or fuel flow 2 is selected and no fuel level senders are selected.

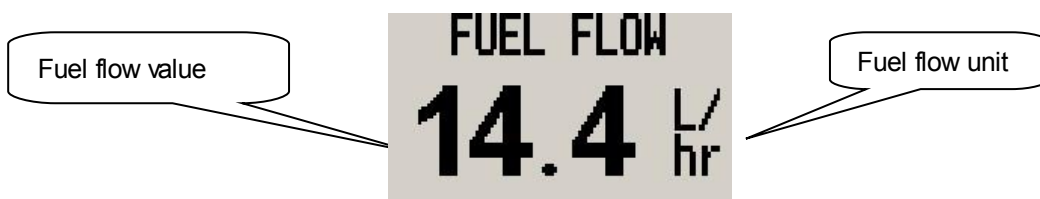

3.5 Dual fuel flow indicator

This mode is displayed if both fuel flow 1 and fuel flow 2 are selected and the fuel mode is selected for dual flow. Both fuel level senders are disabled.

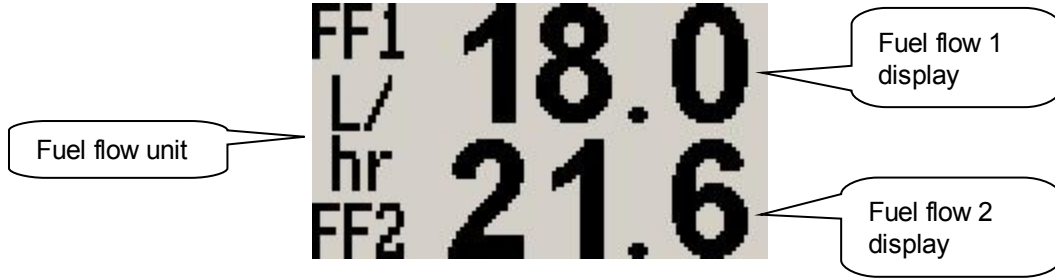

3.6 Single tank level indicator

This mode is displayed if either fuel level 1 or fuel level 2 is selected. Both fuel flow senders are disabled.

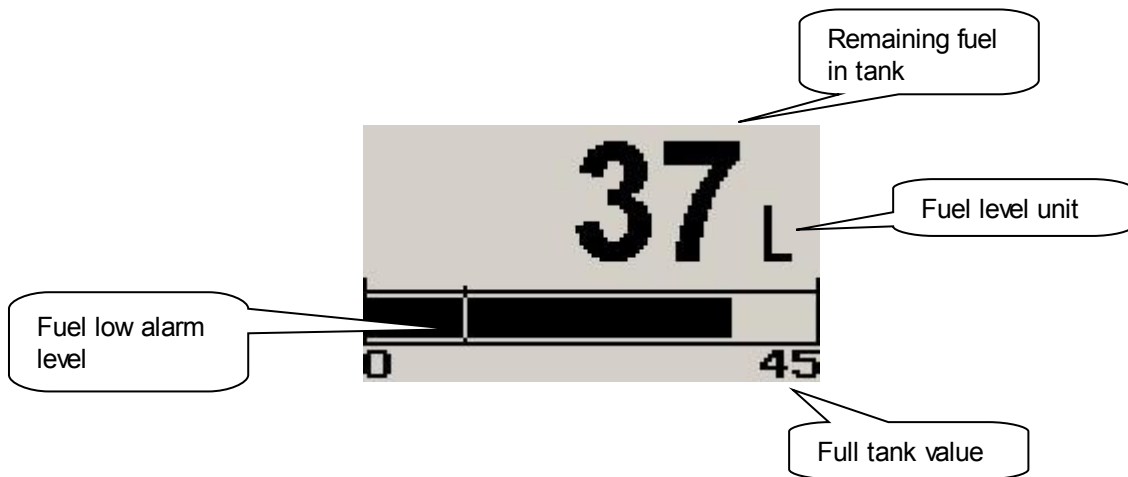

3.7 Dual tank level indicator

This mode is displayed if both fuel level 1 and fuel level 2 are selected. Both fuel flow senders are disabled.

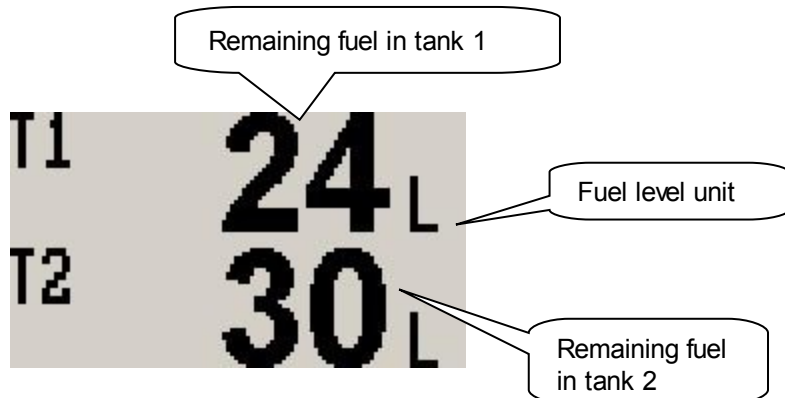

3.8 Differential/Summed fuel flow

This mode is displayed if both fuel flow 1 and fuel flow 2 are selected and the fuel mode is selected for either differential or summed.

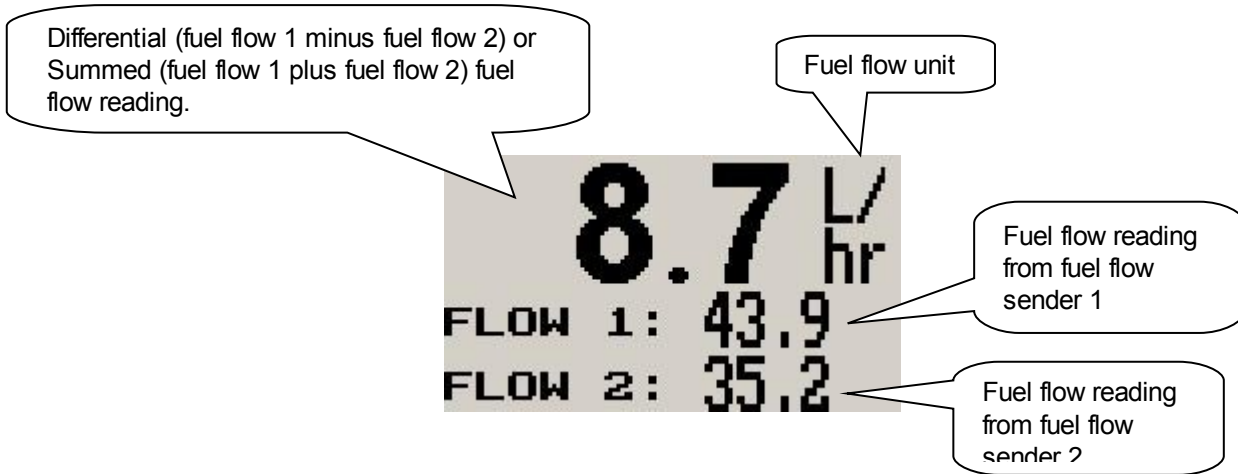

3.9 Enter cruising speed



Press the F1 key during the main display screen to manually enter your aircraft's cruising speed. This value will be used to calculate the fuel range, i.e. how far you can fly with the remaining fuel at zero wind speed. For this calculation, your current remaining fuel, your current fuel flow and the speed entered here are taken into account. You can easily change the speed during flight to reflect changes in ground speed or cruising speed. Use this function with care and do not use it to extend your range. You must at all times have a secondary indication of available fuel. Note that flow senders and level senders may be subject to malfunction that may result in incorrect fuel levels being displayed or calculated. This function is only available in certain display modes and if the speed menu option is set to manual.

3.10 Airtalk airspeed / GPS ground speed display



Pressing the F1 key during the main display will show the current airspeed (using the ASX-1 indicator) or ground speed (using a NMEA enabled GPS receiver). This value is used for fuel range calculations.

3.11 Enter starting level of fuel tanks



Press the F2 key during the main display screen to manually enter your current fuel level after fueling or defueling your aircraft. This function is only available if you have a mode selected where fuel level is calculated from fuel flow.

Note: It is good airmanship to take into account a "silent" fuel reserve. For example, if you have a 50 liter tank and you fill it, enter 40 or 45 liters as your available fuel.

3.12 Incorrect fuel setup message

**SELECT FUEL
MODE IN FUEL
SETUP MENU!**

The following message will be displayed if the FF-1 is setup incorrectly. For example if both fuel flow senders are disabled and a single/dual fuel level(s) are setup for calculated fuel tanks.

4 Menu System

Pressing the rotary control button during the normal display mode will cause the FF-1 to enter the menu system. Use the up/down keys or the rotary control to navigate through the menu system.

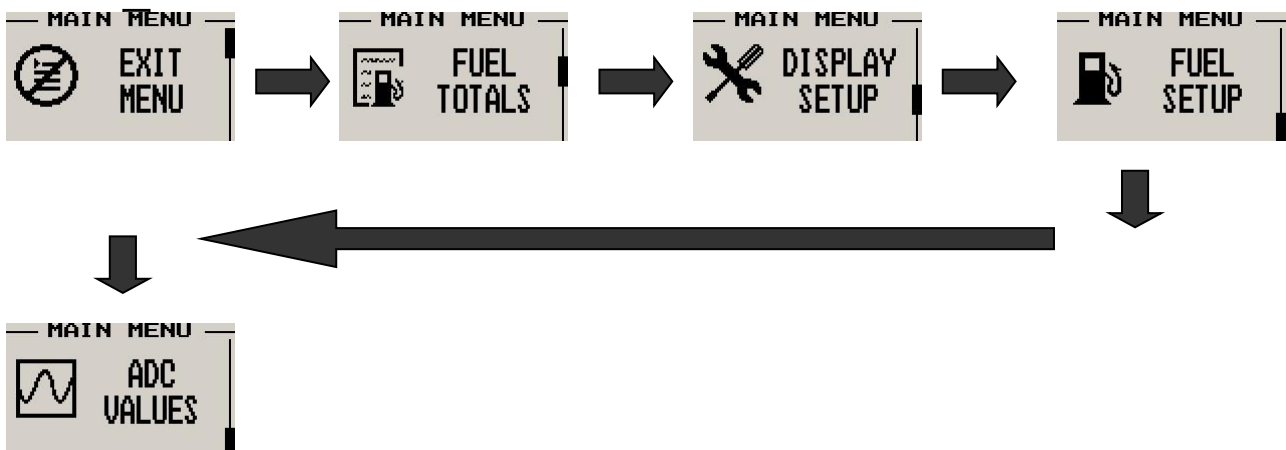

Note: (“ADC Values” menu item is only visible when powering up the unit and pressing the rotary control). The text “CALIBRATE” will appear on the intro screen when entering this mode.

4.1 Exit Menu



Pressing the rotary control on this menu item will cause the FF-1 to exit the menu system. All changes made during navigation of the menu system will be saved in non-volatile memory on exiting the menu system. If you remove power before exiting the menu the instrument will not save any changes.

4.2 Fuel Totals



These are 2 independent accumulators for fuel tank 1 and fuel tank 2 that totalize the amount of fuel burn since the last time the accumulators were reset to zero.

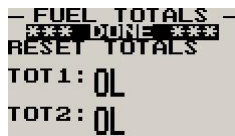

Move the highlight over the “DONE” menu item and press the rotary control to return to the main menu.

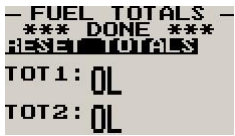

Select this menu option to reset the fuel totalizers to zero.

4.3 Display Setup



Move the highlight over the “DONE” menu item and press the rotary control to return to the main menu.

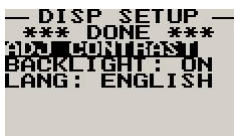

Select this menu option to turn the backlight on or off.

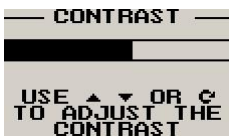

Select this menu option to adjust the display contrast.



Select your preferred language for the FF-1. English or French.

4.4 Fuel Setup

This menu will customize itself to the various options you choose. The full fuel setup menu is shown.

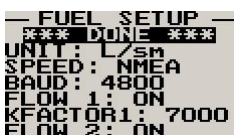

Move the highlight over the “DONE” menu item and press the rotary control to return to the main menu.

Select your desired units for distance and fuel quantity. The following options are available:

```

-- FUEL SETUP --
*** DONE ***
UNIT: L/sm
SPEED: NMEA
BAUD: 4800
FLOW 1: ON
KFACTOR1: 7000
FLOW 2: ON
    
```

- L/sm: Liters and statute miles
- G/sm: U.S. Gallons and statute miles
- L/nm: Liters and nautical miles
- G/nm: U.S. Gallons and nautical miles
- L/km: Liters and kilometers
- G/km: U.S. Gallons and kilometers

```

-- FUEL SETUP --
*** DONE ***
UNIT: L/sm
SPEED: NMEA
BAUD: 4800
FLOW 1: ON
KFACTOR1: 7000
FLOW 2: ON
    
```

Select which speed will be used for range based calculations. You can select between "MANUAL" (Manually enter a cruising speed), "AIRTALK" (airspeed obtained from the ASX-1), or "NMEA" (obtained from a RS232 NMEA enabled GPS receiver) .

```

-- FUEL SETUP --
*** DONE ***
UNIT: L/sm
SPEED: NMEA
BAUD: 4800
FLOW 1: ON
KFACTOR1: 7000
FLOW 2: ON
    
```

Select the Baud rate of your NMEA GPS receiver.

```

-- FUEL SETUP --
*** DONE ***
UNIT: L/sm
SPEED: NMEA
BAUD: 4800
FLOW 1: ON
KFACTOR1: 7000
FLOW 2: ON
    
```

Select if there is a fuel flow sender connected to the FF-1's fuel flow 1 input.

```

-- FUEL SETUP --
*** DONE ***
UNIT: L/sm
SPEED: NMEA
BAUD: 4800
FLOW 1: ON
KFACTOR1: 7000
FLOW 2: ON
    
```

The K-Factor is the number of pulses generated by the fuel flow sender for one liter of fuel. The dual range fuel flow sender supplied by MGL Avionics has a K-Factor of 7000 in the low flow mode (jet installed) and 1330 for the high flow mode (no jet installed). The Flowscan 201A-6 has a K-Factor of 8454. You can use the K-Factor to calibrate your fuel flow sender. See the installation section for more details on how to calibrate and install the fuel flow sender.

```

-- FUEL SETUP --
*** DONE ***
UNIT: L/sm
SPEED: NMEA
BAUD: 4800
FLOW 1: ON
KFACTOR1: 7000
FLOW 2: ON
    
```

Select if there is a fuel flow sender connected to the FF-1's fuel flow 2 input.

```

-- FUEL SETUP --
UNIT: L/sm
SPEED: NMEA
BAUD: 4800
FLOW 1: ON
KFACTOR1: 7000
FLOW 2: ON
KFACTOR2: 7000
    
```

The K-Factor is the number of pulses generated by the fuel flow sender for one liter of fuel. The dual range fuel flow sender supplied by MGL Avionics has a K-Factor of 7000 in the low flow mode (jet installed) and 1330 for the high flow mode (no jet installed). The Flowscan 201A-6 has a K-Factor of 8454. You can use the K-Factor to calibrate your fuel flow sender. See the installation section for more details on how to calibrate and install the fuel flow sender.

```

-- FUEL SETUP --
UNIT: L/sm
SPEED: MANUAL
FLOW 1: ON
KFACTOR1: 7000
FLOW 2: ON
KFACTOR2: 7000
MODE: INJECTOR
    
```

Select if you want to measure fuel flow using a fuel flow sender or by using fuel injectors.

```

-- FUEL SETUP --
SPEED: MANUAL
FLOW 1: ON
KFACTOR1: 7000
FLOW 2: ON
KFACTOR2: 7000
MODE: INJECTOR
INJECTOR: LOW
    
```

Select whether the FF-1 fuel flow input is connected to the high or low side fired fuel injector.

```

-- FUEL SETUP --
FLOW 1: ON
KFACTOR1: 7000
FLOW 2: ON
KFACTOR2: 7000
MODE: INJECTOR
INJECTOR: LOW
    
```

If both fuel flow senders are selected then select if they are operating on individual fuel tanks (dual) or if they are operating in a supply/return type fuel system (differential).

```

-- FUEL SETUP --
FLOW 1: ON
KFACTOR1: 7000
FLOW 2: ON
KFACTOR2: 7000
MODE: INJECTOR
INJECTOR: LOW
TANK SETUP
    
```

Select this menu item to setup the fuel level for fuel tank 1. See below for more details.

```

- FUEL SETUP -
KFACTOR1: 7000
FLOW 2: ON
KFACTOR2: 7000
MODE: INJECTOR
INJECTOR: LOW
TANK 1 SETUP
TANK 2 SETUP
    
```

Select this menu item to setup the fuel level for fuel tank 2. See below for more details.

Fuel level setup. (Only tank 1 setup is shown, follow the same steps for tank 2 setup)

```

- TANK 1 SETUP -
*** DONE ***
LEVEL1: SENDER
T1 SIZE: 45
ALARM 1: ON
ALM 1 VAL: 10
TANK 1 CAL
T1 FILTER: HIGH
    
```

Move the highlight over the "DONE" menu item and press the rotary control to return to the fuel setup menu.

```

- TANK 1 SETUP -
*** DONE ***
LEVEL1: SENDER
T1 SIZE: 45
ALARM 1: ON
ALM 1 VAL: 10
TANK 1 CAL
T1 FILTER: HIGH
    
```

Select if fuel tank 1 has a physical fuel level sender connected to it or if the FF-1 must use a calculation based virtual fuel tank. If you do not want any fuel level information then set this parameter to off.

```

- TANK 1 SETUP -
*** DONE ***
LEVEL1: SENDER
T1 SIZE: 45
ALARM 1: ON
ALM 1 VAL: 10
TANK 1 CAL
T1 FILTER: HIGH
    
```

Enter the size of the fuel tank in your system. It is recommended to choose a size that is slightly less than actual size so you can compensate for sender inaccuracies and give you a measure of reserve fuel.

```

- TANK 1 SETUP -
*** DONE ***
LEVEL1: SENDER
T1 SIZE: 45
ALARM 1: ON
ALM 1 VAL: 10
TANK 1 CAL
T1 FILTER: HIGH
    
```

Select whether to turn the fuel tank 1 level alarm on or off.

```

- TANK 1 SETUP -
*** DONE ***
LEVEL1: SENDER
T1 SIZE: 45
ALM 1 VAL: 10
TANK 1 CAL
T1 FILTER: HIGH
    
```

Enter your desired minimum fuel value that you would like to trigger the fuel low alarm. The fuel low alarm will result in the flashing of the fuel level display and remaining fuel readout. You can also connect a warning lamp to the external alarm output (see installation diagram). Note that the fuel low level will be displayed as a vertical line on your fuel level display. This level is over and above your "silent" fuel reserve.

```

- TANK 1 SETUP -
*** DONE ***
LEVEL1: SENDER
T1 SIZE: 45
ALM 1 VAL: 10
TANK 1 CAL
T1 FILTER: HIGH
    
```

See section 4.4.1 on how to calibrate the fuel level senders.

```

- TANK 1 SETUP -
*** DONE ***
LEVEL1: SENDER
T1 SIZE: 45
ALM 1 VAL: 10
TANK 1 CAL
T1 FILTER: HIGH
    
```

Select the damping factor for the fuel level. A selection of none, low, med or high can be made.

4.4.1 Calibrating the fuel level senders

```

- TANK 1: 393 -
*** DONE ***
MODE: SENDER
0L: 809
9L: 680
18L: 520
27L: 427
36L: 356
    
```

The fuel level sender needs to be calibrated before it can be used with this system. The calibration allows the system to learn the shape of your tank as well as any errors your fuel level sender or installation has.

Regardless of your use of a fuel flow sender, you can install a fuel level sender into your fuel tank. These level senders are inexpensive and are available as after market replacement fittings from a car spares outlet. We recommend the senders available from VDO.

Be aware that some makes of cheap level senders can prove troublesome, as the lever arms tend to be sticky. This prevents the floats from floating on the surface of the fuel at all times. As a consequence, this will lead to incorrect fuel level indication.

Adjusting calibration points automatically

Select "SENDER" for the mode menu item. Once you have installed a fuel level sender into your tank, make sure the float can travel all the way from empty to full position without hindrance of any kind. The calibration procedure should be carried out with your aircraft in flight attitude. This means you need to lift the tail if you have a tail-dragger or lift the nose wheel if you have a weightshift trike.

Calibration procedure

- Start the calibration procedure with an empty tank.
- Add five liters of fuel (our reserve quantity) using a suitable measure. Make sure the measure is suitably accurate. This is now the "level sender reading at 0 Lt" position. Move the highlight to this position and wait until the sender reading has stabilized (You will see the sender reading at the top line). This could take up to a minute so have patience.

ENSURE THAT THE FLOAT IS NOT SUBMERGED AND IS FLOATING ON TOP OF THE FUEL LEVEL.

Should this number not react to changes of your level sender position, then you have a problem. Please check your wiring according to the installation section of this manual. You should expect the number to change in the region of at least 20 to 60 counts per calibration position. If the number does not change with fuel level or only changes a very small amount – check your installation. Something is not right!

- If you see the number changing then everything is well. Once it has stabilized and the highlight is on the 0 L position, press the rotary control to transfer the reading from the sender to the calibration point.
- Now you are ready for the next step. Add the required amount of fuel to get to the next level (In our case 9 Lt – this is 20% tank capacity). Once done, wait for the reading to stabilize and press the rotary control again after you have moved the highlight to the "9 L" position.
- Proceed in a similar manner until you have reached the last calibration position at 100% tank capacity.

You are done!

To finish your calibration, exit the calibration function by moving the highlight over the "DONE" menu item and press the rotary control.

The instrument uses the 6 calibration points to work out a correction curve that takes into account the tolerances of your fuel level sender and the shape of your fuel tank. This results in an incredibly accurate and usable fuel level display that far exceeds that available from ordinary dial type gauges.

Adjusting calibration points manually

```

— TANK 1 CAL —
*** DONE ***
MODE: MANUAL
0L : 805
9L : 680
18L : 520
27L : 427
36L : 356
  
```

You may want to set individual calibration points manually. For example you may find that your fuel level is over reading at a specific fuel level. Correcting the tank level reading for this area can be simply done by adjusting the calibration point. You can do this by moving the float level with your hands to the desired position and then performing the calibration as outlined above, or you can use the manual option.

Select "MANUAL" for the mode menu item. Then highlight the point you want to change manually and press the rotary control. Use the up or down keys or the rotary control to adjust the value. Press the rotary control when done.

Note: The calibration positions may be edited by using the up and down keys. This allows you, in theory, to copy calibration settings from one instrument to another. We however recommend that you do go through the calibration procedure even if the two aircraft are identical in all respects. Tolerances do exist and the calibration cancels these out. Accurate fuel level displays are a vital safety factor for an aircraft and a very useful feature for peace of mind during cross county flights.

Notes on Slope error



Sender value is a value determined by the FF-1. It is used to calculate fuel level, fuel endurance estimate and current range estimate. The fuel tank setup sender value can either increase in value as fuel is added or decrease in value if fuel is added. This is dependant on the type of fuel level sender used. However should the second reading be larger than the first reading all readings will have to be larger than the previous readings. Likewise should the second reading be smaller than the first reading all readings will have to be smaller than the previous reading.

If this is not the case the wording "Slope error" will be displayed. This could happen when fuel was removed instead of added between steps, no fuel was added between steps or when the fuel level sender was moved in the wrong direction e.g. moving the fuel level sender manually when it is not inserted in to the fuel tank. Determine the cause of the error if you should get a slope error message. If you do not know the cause of your error it is best to start from scratch. It should be remembered that accuracy in the fuel tank calibration is extremely important to enable your FF-1 to display the correct data.

4.5 ADC Values

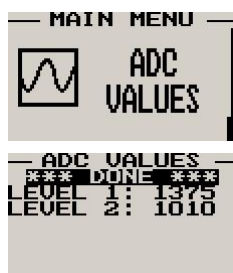

Note: This menu item is for technical personnel only, and is not displayed during the normal operation of the instrument. Please see section 4 above on how to access this menu item.

This menu displays the ADC values that have been read from the two fuel level senders.

5 Loading factory default settings

Pressing and holding the F1 and F2 keys simultaneously on power up will cause the FF-1 to load preprogrammed factory default settings. The following screen will be displayed:

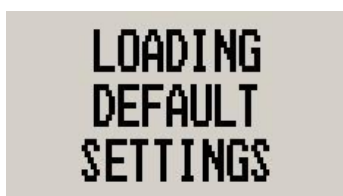

6 Operating the alarms

If the alarm is activated, the corresponding item on the display will flash. At the same time the externally available alarm switch will close. The switch will remain closed until any button is pressed to acknowledge the alarm or until the condition(s) that activated the alarm no longer exist. The alarm output can be used to switch an external alarm indicator. The external alarm switch is an open collector transistor switch to ground with a maximum rating of 0.5A DC. It is possible to wire the alarm contacts of several Stratomaster instruments in parallel should this be desired. To avoid false activation of the alarms, the alarm function is only active 10 seconds after the instrument has powered up.

7 Airtalk speed input message

The FF-1 will accept a speed message from an airspeed type indicator such as a Stratomaster Infinity ASX-1 (Encoding aviation altimeter with serial output and airspeed Indicator (ASI)). The FF-1 uses this information to calculate the fuel range, i.e. for how far you can fly with the remaining fuel. For this calculation, your current remaining fuel, your current fuel flow and the speed information are taken into account.

The MGL avionics airtalk protocol uses 19200 baud, 8 data bits, one stop bit and no parity.

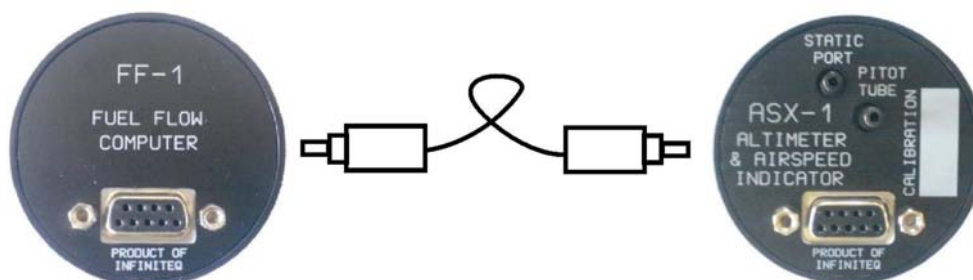

8 RS232 NMEA enabled GPS receiver message

The Infinity FF-1 has the ability to be connected to a NMEA enabled RS232 GPS receiver to allow the FF-1 to use the actual ground speed in determining the fuel range. For this calculation, your current remaining fuel, your current fuel flow and the ground speed information are taken into account. The Baud rate can be setup in the FF-1 for 1200 to 19200 Baud. **An additional GPS NMEA interface cable is required.**

The NMEA enabled RS232 GPS receiver must be able to output a GPRMC message (The Recommended Minimum sentence defined by NMEA for GPS/Transit system data.) This message is defined as:

```
$GPRMC,hhmmss,status,latitude,N,longitude,E,spd,cog,ddmmyy,mv,mvE,mode*cs<CR><LF>
```

Example: \$GPRMC,083559.00,A,4717.11437,N,00833.91522,E,0.004,77.52,091202,,A*57

9 Cleaning

The unit should not be cleaned with any abrasive substances. The screen is very sensitive to certain cleaning materials and should only be cleaned using a clean, damp cloth.

Warning: The FF-1 is not waterproof. Serious damage could occur if the unit is exposed to water and/or spray jets.

10 FF-1 Specifications

Operating Temperature Range	-10°C to 50°C (14°F to 122°F)
Storage Temperature Range	-20°C to 80°C (-4°F to 176°F)
Humidity	<85% non-condensing
Power Supply	8 to 30Vdc SMPS (switch mode power supply) with built in 33V over voltage and reverse voltage protection
Current Consumption	Approx. 40mA @ 13.8V (backlight on) 10mA @13.8V (backlight off)
Display	114x64 graphic LCD display. Contrast and backlight is user configurable, green/yellow backlight
Dimensions	see Infinity series dimensional drawing
Enclosure	2 1/4" ABS, black in color, front or rear mounting
Weight	Approx. 124 grams
Non-volatile memory storage	100000 write cycles
Fuel level input	Maximum voltage: 5V, 5mA maximum current
Fuel level senders supported	Any resistive type with common ground and capacitate probes with active voltage outputs up to 5V level (push pull or pullup)
Fuel flow senders	Supply 5V, 40mA maximum current. TTL level input with noise filter and Schmitt-trigger hysteresis. Required input voltage swing: less than 1.5V to more than 3.5V. Maximum input voltage range -5V to +18V
Airtalk protocol	19200 baud, 8 data bits, no parity, 1 stop bit (TTL voltage levels)
NMEA Baud rate	Selectable - 1200,2400,4800,9600,19200

11 Installation

11.1 Cable connections

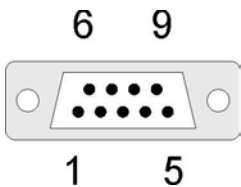

DB 9 Pin	Color	Function
1	Black	Ground
2	Orange	Fuel level 1 sender
3	Green	Fuel level 2 sender
4	RCA (Inner cable)	Airtalk communication Used for firmware upgrading and airtalk speed message (ASI-1/ASX-1)
5	Blue	Fuel flow sender 1 signal
6	Red	8-30Vdc power
7	Brown	+5V DC Power out for fuel flow senders
8	Yellow	Fuel flow sender 2 signal
9	White	Alarm output

11.2 Connection Diagram

The use of an external 1A fuse is recommended. Connect the supply terminals to your aircrafts power supply. The FF-1 can be used on both 12V and 24V without the use of any pre-regulators. Ensure that the supply voltage will not drop below 8V during operation as this may result in incorrect displays.

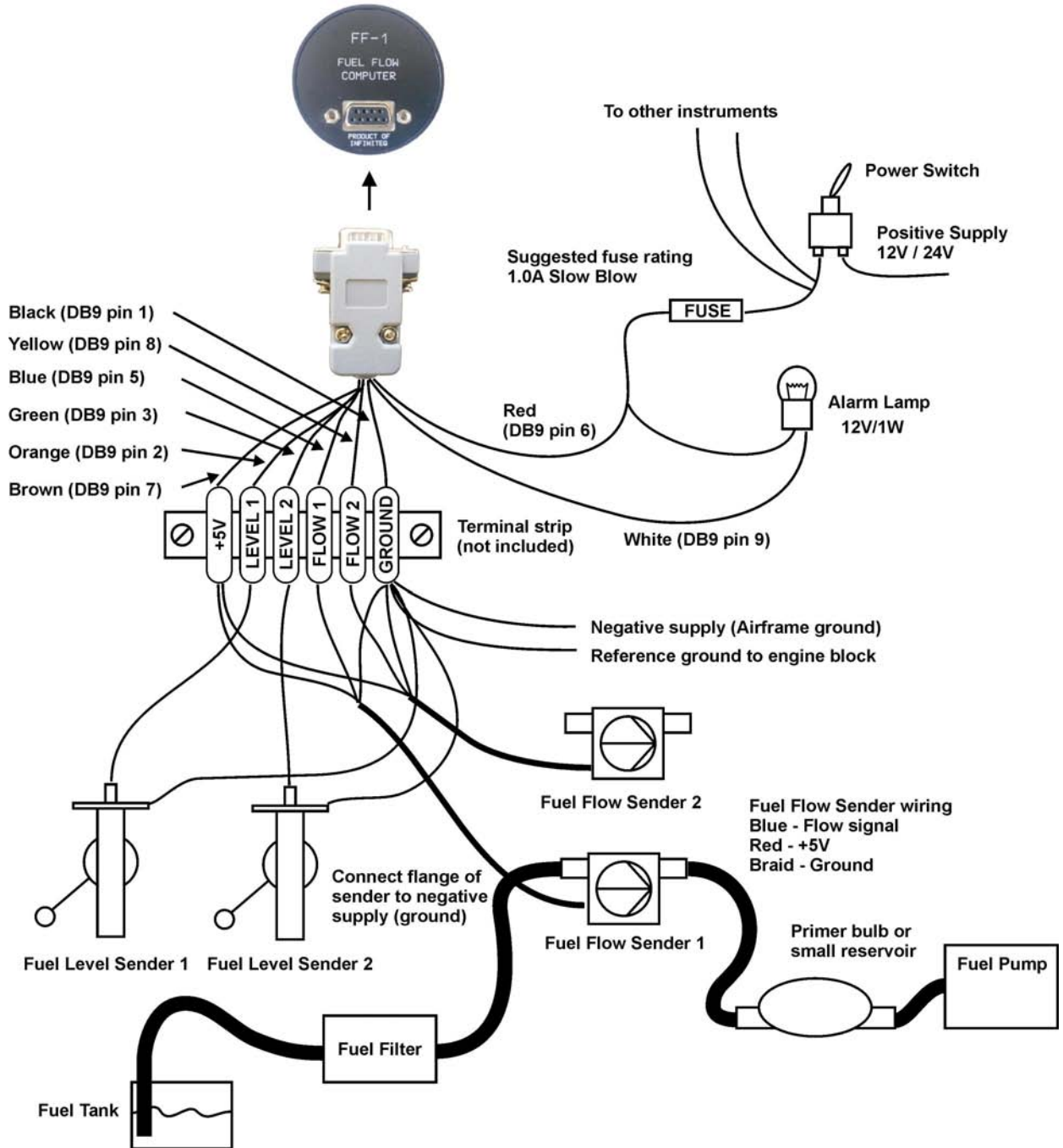

11.3 Fuel flow sender installation

The fuel flow sender allows the FF-1 to provide instantaneous readouts of hourly fuel usage, and both time and distance estimates on remaining fuel in flight. You can also verify the performance of your fuel pump during the pre-takeoff engine run up – a very valuable check! Further, it is possible to set up the instruments to calculate fuel remaining by subtracting fuel used from a value entered when you filled your tank(s). In this case you may omit the installation of the optional fuel level sender. Please note that the installation of the fuel Flow sender should be done in such a fashion that dirt or debris from the fuel tank cannot lodge inside the flow sender. These will not block you fuel flow but may lead to the impeller inside the sender jamming. It is usually sufficient to mount the flow sender **AFTER** the fuel filter but before the fuel pump. It is a good idea to provide a small reservoir such as a primer bulb between the flow sender and the fuel pump.

As indicated in the recommended installation drawing, it can be of advantage to install the flow sender in such a fashion that the inlet points slightly down and the outlet points slightly up. This prevents vapor from forming a bubble inside the flow sender. We strongly recommend mounting the flow sender in such a fashion that the impeller rests on only one bearing. This is achieved if you mount the sender such that the surface with the arrow faces upwards. Mounting the sender like this results in the best performance at low flow rates as only very little friction is present. The flow sender is delivered with a small jet that can be installed in the flow sender inlet. Installation of this jet is recommended for engines with fuel flow rates lower than about 30 liters per hour. This would apply to most small two and four stroke engines. The FF-1 is shipped with the fuel flow sender calibration set for the jet installed. In a good installation you can expect about +/- 3% maximum flow reading error with this factor. You can calibrate the flow sender yourself to a higher degree of accuracy if you so desire.

Recommended procedure to calibrate the fuel flow sender:

Note: You must disable the fuel level sender if you have one installed, and enable the calculated fuel level sender.

1. Fill your tank exactly to a known level (for example 50 liters).
2. Set your fuel level to 50 liters.
3. Fly your aircraft for a period that you know will use approximately 20 liters of fuel. The exact fuel burn is not important; just burn about 20 liters of your fuel. At the end of your flight the instrument should give you a reading of how much fuel you have left – the reading should be about 30 liters left.
4. Now place your aircraft in exactly the same position that you used when you first filled the tank and refill the tank to 50 liters using a measuring jug. You should find that you need 20 liters of fuel to refill to 50 liters.
5. If you find that the instrument under or over reads the fuel used, you should perform a simple adjustment of the fuel flow sender calibration factor.

Example:

Actual fuel used: 21.5 liters, FF-1 fuel burn calculated 29.7 liters left in the tank. This means the FF-1 measured $50 - 29.7 = 20.3$ liters. We are under reading by 1.2 liters.

Default calibration factor in Fuel setup menu = 7000.

Let the corrected calibration factor be X.

$$X = (20.3 * 7000) / 21.5$$

$$X = 6609.3$$

The closest setting you can enter as factor is 6609. Enter it into the unit and you are done!

Repeat the above procedure to verify that your flow sender is now reading correctly.

Please note:

Before you calibrate the flow sender ensure there are no problems with your installation. We find the senders are very accurate if everything is installed and working properly. If your fuel burn indication is out by a large amount you have a problem that you should not attempt to fix by fiddling with the calibration factor! Please ensure that no fuel vapor can be trapped inside the sender housing in the form of bubbles. Due to the low fuel flow rates the bubbles will prevent the tiny impeller from turning freely, you can verify the turning of the impeller. You should notice three dark spots that are just visible in the inside of the fuel flow sender. These are small magnets that are attached to the impeller. With fuel flowing you should see the magnets turning. The best defense against vapor bubbles is to install the flow sender in such a way that the bubbles can escape. The easiest way is to point the outlet slightly upwards and the inlet (with the jet) slightly

downwards. Another possible problem is the fuel sender jet. When you install it, do not damage it. Use a drill bit of suitable diameter (5.5mm) to push the jet all the way, the opening of the jet must be just in front of the impeller.

YOU NEED TO APPLY SOME FORCE TO INSERT THE JET ALL THE WAY (about 24mm). THE JET MUST BE LOCATED RIGHT IN FRONT OF THE IMPELLOR. YOU CANNOT PUSH THE JET TOO FAR.

Using other Flow Senders

It is quite possible to use flow senders other than the MGL Avionics fuel flow sender. In this case ensure that the sender outputs a 5V TTL square wave or a similar signal. The FF-1 interface electronics will adapt to a variety of different voltages and pulse shapes as it contains a Schmitt-trigger input stage. The calibration factor can be entered in a wide range making the unit particularly suited to other flow senders. The supply output terminal for the sender provides a positive, regulated 5 volt output. This may be used to power the flow sender provided the sender will not draw more than 40 mA of current. Should your sender require a higher voltage or more current, you must supply the sender from a different power source. Exceeding the rating on the MGL Avionics fuel flow sender supply terminal can affect the operation on the unit negatively or even damage it. Some senders require a pull-up resistor to the 12V supply line. We find most installations of these senders require a 4K7 pull-up resistor.

Recommended Calibration Factors for the MGL Avionics dual range flow sender:

With jet installed = 7000. Recommended for flow rates below 30 liters/hour maximum

Without jet installed = 1330. Recommended for flow rates above 30 liters/hour

Please refer to the leaflet included with the flow sender for information on pressure drop versus flow rate, wetted materials etc.

It is your responsibility to ensure that the flow sender used is compatible with the fuels you intend using. We have found the MGL Avionics fuel flow sender to be very compatible with automotive fuels used in South Africa, many of which contain methanol. 100LL AVGAS also appears not to harm the sender in any way. We have exposed a sender continuously to our automotive fuels for the duration of two years without any noticeable ill effect on the sender. However, despite this MGL Avionics or its appointed agents cannot assume responsibility for any incident or damage, even loss of life by whatsoever cause connected with the fuel flow sender or the FF-1 instrument. Usage of this or other senders is your own sole responsibility.

If you do not agree with the above statement you must not use the fuel flow sender.

Note to Pilots: (Even though this is the installation manual)

You must always have a visual indication of the fuel level available, either by means of a sight glass, direct tank observation or a known, reliable secondary fuel level gauge. Fuel level indication by means of calculated fuel burn is subject to errors both by entering incorrect starting fuel levels as well as mechanical problems causing the flow sender impeller to turn too slowly, resulting in under reading fuel burn and thus over reading remaining fuel. As pilot in command of an aircraft it is your responsibility to ensure that you have sufficient fuel to reach your intended destination. Always ensure that you have a generous amount of reserve fuel and never use your reserve fuel except in an emergency if it is unavoidable.

11.4 Floscan 201 fuel flow sender installation

1. The inlet and outlet ports in series 201 flow transducers have ¼" NPT threads. Use only ¼" NPT hose or pipe fittings to match. When assembling fittings into the inlet and outlet ports DO NOT EXCEED a torque of 15 ft. lbs. (180 inch lbs.), or screw the fittings in more than 2 full turns past hand tight, WHICHEVER COMES FIRST. FloScan Instrument Co., Inc. will not be responsible for cracked castings caused by failure to use ¼" NPT fittings, over torquing the fittings, or assembling them beyond the specified depth.
2. A screen or filter should be installed upstream of the flow transducer to screen out debris which could affect rotor movement or settle in the V-bearings. As turbulence upstream of the transducer affects its performance, there should be a reasonable length of straight line between the transducer inlet and the first valve, elbow, or other turbulence-producing device.
3. Install the flow transducer with wire leads pointed UP to vent bubbles and insure that rotor is totally immersed in liquid. For maximum accuracy at low flow rates the transducer should be mounted on a horizontal surface.
4. Power supply: 12 VDC at 100mA filtered and regulated.

- Series 200 flow transducers are designed to measure steady state flows. Indicated accuracies and pulse counts were obtained using heptane on a flow stand with rotary pumps and are reproducible in flow systems using rotary or gear pumps. Fuel systems with diaphragm fuel pumps and carburetors produce pulsating fuel flows. For accurate results on these systems consult the factory for the correct flow transducer/pulsation damper combination.

Wiring the Floscan Flow Transducer

The FF-1 unit measures the output from the transducer. A 5600 ohm (5k6) pull-up resistor is required. See wiring table and installation diagram below.

The gallon per hour K-Factor for the 201A-6 transducer is approximately 32,000. The K-Factor of each sensor (at 16 GPH), divided by 10, is written on a label attached to sensor. Multiply this number on the label by 10, which should give a value of approximately 32,000. The FF-1 requires a litre per hour K factor. Take the gallon per hour K factor, and divide it by 3.785 (which yields a K-Factor of approximately 8454).

Floscan transducer wire color	FF-1 DB9 Terminal/Other Terminal
White	Fuel flow sender 1 (DB9 pin 5 – Blue) Fuel flow sender 2 (DB9 pin 8 – yellow)
Black	FF-1 ground (DB9 pin 1 – Black) / Aircraft ground / Engine block
Red	+12V DC Supply (Not supplied by the FF-1)

Floscan connection diagram

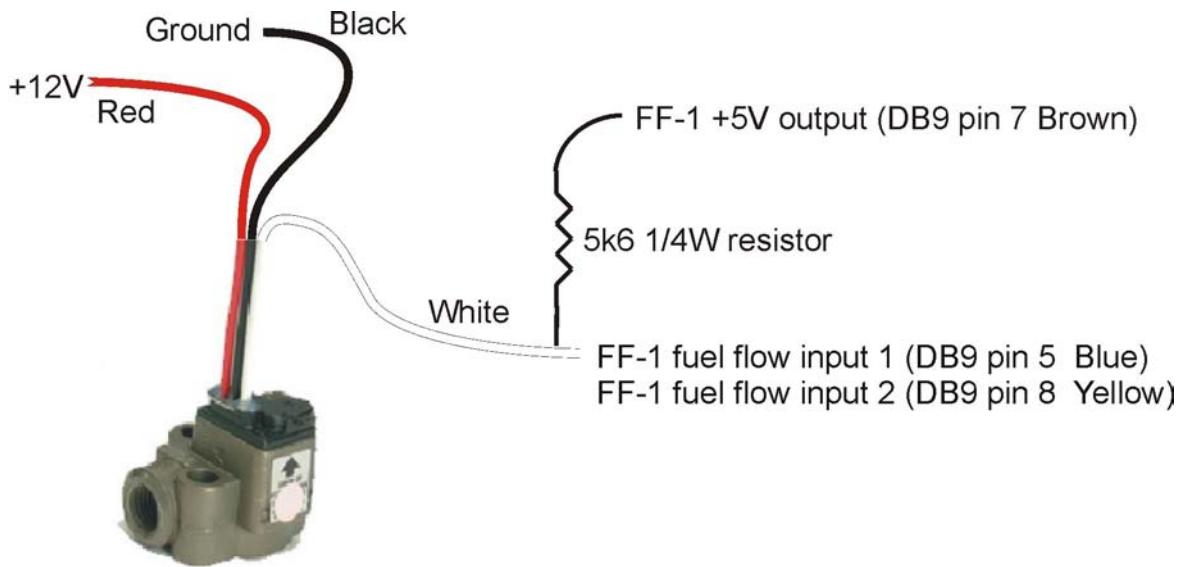

	Model 201A-6	Model 201B-6	Model 201C-6
Flow range: Gasoline	0.3 – 30 GPH	0.6 – 60 GPH	2.0 - 80 GPH
Flow range: #2 Diesel	2.0 – 30 GPH	3.0 – 60 GPH	8.0 – 80 GPH
Approximate K-Factor ¹ : Gasoline	32 000	28 000 – 31 000	24 000
Approximate K-Factor ¹ : Diesel	33 000	28 000	25 000
Pressure Drop: Gasoline	0.6psi @ 15 GPH 2.4psi @ 30GPH	1.2psi @ 30 GPH 4.8psi @ 60GPH	1.4psi @ 40 GPH 5.8psi @ 80 GPH
Pressure Drop: #2 Diesel	0.8psi @ 15GPH 3.0psi @ 30GPH	1.5psi @ 30GPH 6.0psi @ 60GPH	1.8psi @ 40GPH 7.2psi @ 80GPH
Repeatability between measurements	0.25% @ 16GPH	0.25% @ 16GPH	0.25% @ 16GPH
Working pressure	200psi	200psi	200psi
Temperature range	-65°/100°C	-65°/100°C	-65°/100°C
Bearing life expectancy	10 000 hr min.	10 000 hr min.	10 000 hr min.

Notes:

1. Pulses/Gallon @ 16 GPH

2. All flow transducers are tested and marked with K-factor at 16 GPH. Repeatability at 16 GPH is guaranteed to 0.25%. Transducers are available with calibrated K-factors at additional cost

11.5 Fuel level sender installation

The FF-1 permits the connection of one or two standard automotive fuel level senders. These senders can be obtained at automotive spares outlets at reasonable cost. When you choose a float level sender, ensure that you select a model that is sturdy and promises reliable and long lifetime. In particular, select a model that does not have any metal parts that can rust. The FF-1 can interface to a large variety of these fuel level senders. It does not matter if the sender resistance increases or decreases with the fuel level as long as it changes. The calibration procedure outlined in the “Fuel Setup” section describes in great detail the procedure to follow.

In essence, the calibration procedure will measure the resistance of the fuel level sender at various fuel levels and then work out the readings in between those known settings. Typical fuel level senders that can be used with the FF-1 have resistance ranges in the region of 100 ohms to 500 ohms. Connect the flange of the sender to the negative supply (ground). You can connect capacitive senders as well. These generally come in two types: The first emulates a normal resistive probe and is simple to connect and use as a result. The second type has a voltage level output. These can be used if the voltage can be set to a range of about 0-5V. Higher voltage levels will result in the instrument assuming a problem. The FF-1 supports one or two fuel tank level senders. You need to enable these in the “Fuel Setup” menu.

We recommend using VDO float based fuel level senders. Capacitive types can be used provided they have a voltage output not exceeding 5V. The level terminal has an internal 1K resistor pull-up to 5V. Please note that capacitive senders may exhibit large errors as they are very sensitive to the composition of the fuel used. We do not recommend using capacitive senders with automotive fuels for this reason.

Safety Hazard! Please take note:

Be careful when installing fuel level senders into fuel tanks. Ensure that the fuel tank is completely empty when you proceed with the installation. Ensure that the fuel tank is well ventilated and does not contain any fuel vapors – these are highly explosive when mixed with air. Ensure that at all times the ground connection (the connection of the fuel level sender mounting flange) is securely connected to the aircraft frame (in case of a metal frame) and to the negative terminal of the battery. In addition the negative terminal of the battery must at all times be connected to the supply ground terminal of the FF-1. Please note – this wiring is critical and must never break in flight. It would be possible to create electrical sparks in the fuel tank if your wiring is faulty or incorrect. The consequences of this can be imagined. This has nothing to do with the FF-1 itself but is a general hazard for any automotive fuel level sender installation. If you have no experience with electrical wiring, **PLEASE** delegate the task to a qualified automobile electrician or electronics technician. If you need to remove the FF-1, please first disconnect and secure the fuel level sender wire before disconnecting anything else.

11.6 Fuel injector systems

Should you want to monitor fuel flow directly by means of measuring the fuel injector opening time, the connection as in the diagram below can be used. You can use either high or low fired injectors (most systems are low side fired as shown below). After you have connected the system as shown below you can proceed to set up the system. (don't forget that you need a connection from the FF-1 ground terminal to the engine block (at the same potential as the battery negative).

- Select high or low side fired injector in the Fuel Setup menu.
- Enable the flow sender in the Fuel Setup menu.
- Select a suitable K-factor in the calibration menu to give you correct rate of flow. A good starting value may be in the 1500-2000 range. Increase to lower indicated flow and decrease to have a larger indicated flow.

Flow through the injectors may not be 100% linear with switching times due to various effects. However, it is possible to obtain very good performance from this flow monitoring system if you keep the following in mind: Calibrate the K-factor so flow indication is accurate during cruise, the period your engine spends most of its active time at. Ensure that you have a correctly working fuel pressure regulator. The more constant your fuel pressure, the more accurate the flow indication.

Never use this or any other flow system as your only fuel level indication. This is not the intended purpose of a flow measuring system and this can be dangerous if for whatever reason incorrect flow is indicated.

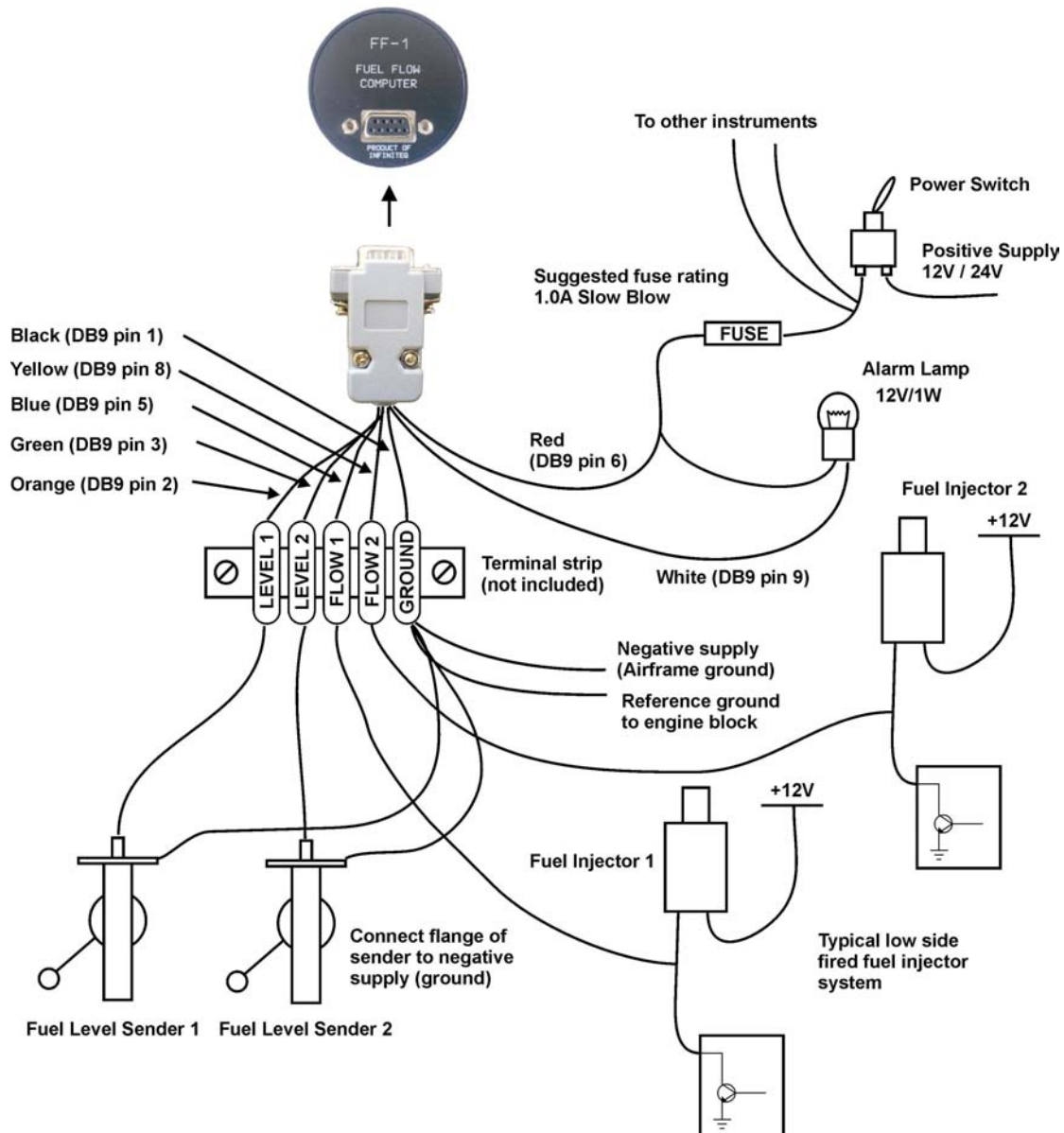

12 Warranty

This product carries a warranty for a period of one year from date of purchase against faulty workmanship or defective materials, provided there is no evidence that the unit has been mishandled or misused. Warranty is limited to the replacement of faulty components and includes the cost of labour. Shipping costs are for the account of the purchaser.

Note: Product warranty excludes damages caused by unprotected, unsuitable or incorrectly wired electrical supplies and or sensors, and damage caused by inductive loads.

13 Disclaimer

Operation of this instrument is the sole responsibility of the purchaser of the unit. The user must make themselves familiar with the operation of this instrument and the effect of any possible failure or malfunction.

This instrument is not certified by the FAA. Fitting of this instrument to certified aircraft is subject to the rules and conditions pertaining to such in your country. Please check with your local aviation authorities if in doubt. This instrument is intended for ultralight, microlight, homebuilt and experimental aircraft. Operation of this instrument is the sole responsibility of the pilot in command (PIC) of the aircraft. This person must be proficient and carry a valid and relevant pilot's license. This person has to make themselves familiar with the operation of this instrument and the effect of any possible failure or malfunction. Under no circumstances does the manufacturer condone usage of this instrument for IFR flights.

The manufacturer reserves the right to alter any specification without notice.

Other instruments in the *Stratomaster Infinity* series

ALT-1	Precision encoding altimeter and vertical speed indicator
ALT-2	Precision encoding altimeter and vertical speed indicator with a serial RS232 transponder output
ASI-1	Airspeed indicator (ASI) with automatic flight log
ASX-1	Encoding aviation altimeter with serial output and airspeed indicator (ASI)
AV-1	Artificial horizon and magnetic compass indicator
BAT-1	Battery voltage and current monitor
E-3	Universal engine monitor
FF-1	Fuel Computer (single or dual fuel tanks)
GF-1	+/-10G tilt compensated dual range G-force meter
MAP-1	Manifold pressure and RPM Indicator
RV-1	Universal engine RPM and rotor RPM Indicator
RV-2	Universal turbine RPM / RPM factor display
RTC-2	Aviation real time clock (RTC) and outside air temperature (OAT) display
TC-1	4-Channel thermocouple indicator
TP-1	Universal temperature and pressure gauge